

Intelligent Tunable White LED Driver (Constant Current)

- Housing made from SAMSUNG/COVESTRO's V0 flame retardant PC materials.
- Ultra small, thin and lightweight, screwless end cap.
- Change the dimming interface, output current, DALI address and other parameters via the APP.
- Set the DALI group and scene in the advanced DALI template via the APP.
- Adjustable output current with 1mA step.
- Soft-on and fade-in dimming function enhances your visual comfort.
- T-PWM™ super deep dimming technology, 0.01% dimming depth.
- The whole dimming process is flicker-free with high frequency exemption level.
- Comply with the EU's ErP Directive, networked standby<0.5W.
- When there is no load, the output will be 0V to prevent damage to LEDs due to poor contact.
- Overheat, over voltage, overload, short circuit protection and automatic recovery.
- Suitable for Class I / II / III indoor light fixtures.
- Normal service life can reach 100,000 hours.
- 5-year warranty (Rubycon capacitor).



T-PWM™
Dimming Technology

Flicker Free
IEEE 1789

Dimmable:
10000 : 1

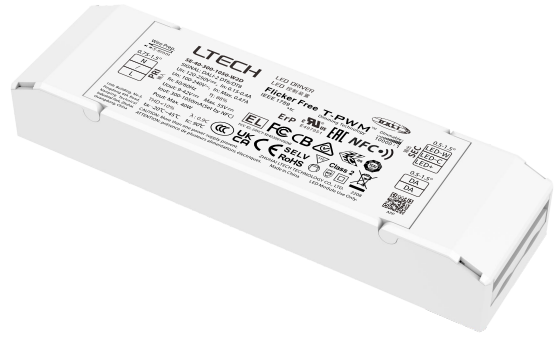

Technical Specs

Model		SE-40-300-1050-W2D		SE-30-200-800-W2D	
Features	Output Type	Constant current			
	Dimming Interface	DALI-2 T6/DT8			
	Output Feature	Isolation			
	Protection Grade	IP20			
OUTPUT	Insulation Grade	Class II (Suitable for class I / II / III light fixtures)			
	Output Voltage	9-42Vdc			
	Maximum output voltage	≤55Vdc			
	Output Current Range	300-1050mA	200-800mA		
	Output Power Range	2.7W-40W	1.8W-30W		
	Dimming Range	0-100%, down to 0.01%			
	LF Current Ripple	<3%(Maximum current for non dimming state)			
	Current Accuracy	±5%			
INPUT	PWM Frequency	≤3600Hz			
	DC Voltage Range	120-250Vdc			
	AC Voltage Range	100-240Vac			
	EoFi	100%			
	Input Voltage	115Vac/230Vac			
	Frequency	50/60Hz			
	Input Current	≤0.45A/115Vac, ≤0.22A/230Vac	≤0.34A/115Vac, ≤0.17A/230Vac		
	Power Factor	PF>0.95/115Vac (at full load), PF>0.9C/230Vac (at full load)			
	THD	THD≤10%/230Vac, at full load			
	Efficiency [Typ.]	88%	87%		
ENVIRONMENT	Inrush Current	Cold start 25A(Test twidth=130us tested under 50% Ipeak)/230Vac			
	Anti Surge	L-N: 2KV			
	Leakage Current	Max. 0.5mA			
	Working Temperature	ta: -20 ~ 45°C tc: 90°C			
	Working Humidity	20 ~ 95%RH, non-condensing			
PROTECTION	Storage Temperature/Humidity	-40 ~ 80°C/10-95%RH			
	Temperature Coefficient	±0.03%/°C(0-50°C)			
	Vibration	10-500Hz, 2G 12min/1cycle, 72 min for X, Y and Z axes respectively			
	Overload Protection	Automatically protect the device when the load exceeds 102% of the rated power. Automatically recover once load is reduced			
SAFETY & EMC	Overheat Protection	Intelligently adjust or turn off the current output if the PCB temperature >110°C. When the PCB temperature <90°C, automatically recover normal output			
	Overvoltage Protection	Automatically protect the device when voltage exceeds the no-load voltage. It can be recovered automatically			
	Short Circuit Protection	Enter hiccup mode if short circuit occurs, and recover automatically			
SAFETY & EMC	Withstand Voltage	I/P-O/P: 3750Vac			
	Insulation Resistance	I/P-O/P: 100MΩ/500VDC/25°C/70%RH			
	Safety Standards	CCC	China	GB19510.1, GB19510.14	
		TUV	Germany	EN61347-1, EN61347-2-13, EN62493	
		CB	CB Member States	IEC61347-1, IEC61347-2-13	
		CE	European Union	EN61347-1, EN61347-2-13, EN62384	
		KC	Korea	KC61347-1, KC61347-2-13	
		EAC	Russia	IEC61347-1, IEC61347-2-13	
		RCM	Australia	AS 61347-1, AS 61347-2-13	
		ENEC	Europe	EN61347-1, EN61347-2-13, EN62384	
		UKCA	Britain	BS EN 61347-1, BS EN 61347-2-13, BS EN 62493	
		BIS	India	IS 15885 (PART 2/SEC 13)	
	CUL	Canada	CSA C22.2 NO.250.13		
	UL	America	UL 8750		
	EMC Emission	CCC	China	GB/T17743, GB17625.1	
CE		European Union	EN55015, EN61000-3-2, EN61000-3-3, EN61547		
KC		Korea	KSC 9815, KSC 9547		
EAC		Russia	IEC62493, IEC61547, EH55015		
RCM		Australia	EN55015, EN61000-3-2, EN61000-3-3, EN61547		
UKCA		Britain	BS EN IEC 55015, BS EN IEC 61000-3-2, BS EN 61000-3-3, BS EN 61547		
CUL	Canada	ICES-005			
UL	America	FCC PART 15B			
EMC Immunity	EN61000-4-2,3,4,5,6,8,11, EN61547				
ErP	Power Consumption	Networked standby	<0.5W (After shutdown by command)		
		No-load power consumption	<0.5W (When the lamp is not connected)		
	Flicker/Stroboscopic Effect	IEEE 1789	Meet IEEE 1789 standard/High frequency exemption level		
		CIE SVM	Pst LM≤1.0, SVM≤0.4		
OTHERS	DF	Phase factor	DF>0.9		
	Weight(N.W.)	170g±10g	150g±10g		
	Dimensions	142×40×23mm(L×W×H)			

Product Size

Unit: mm

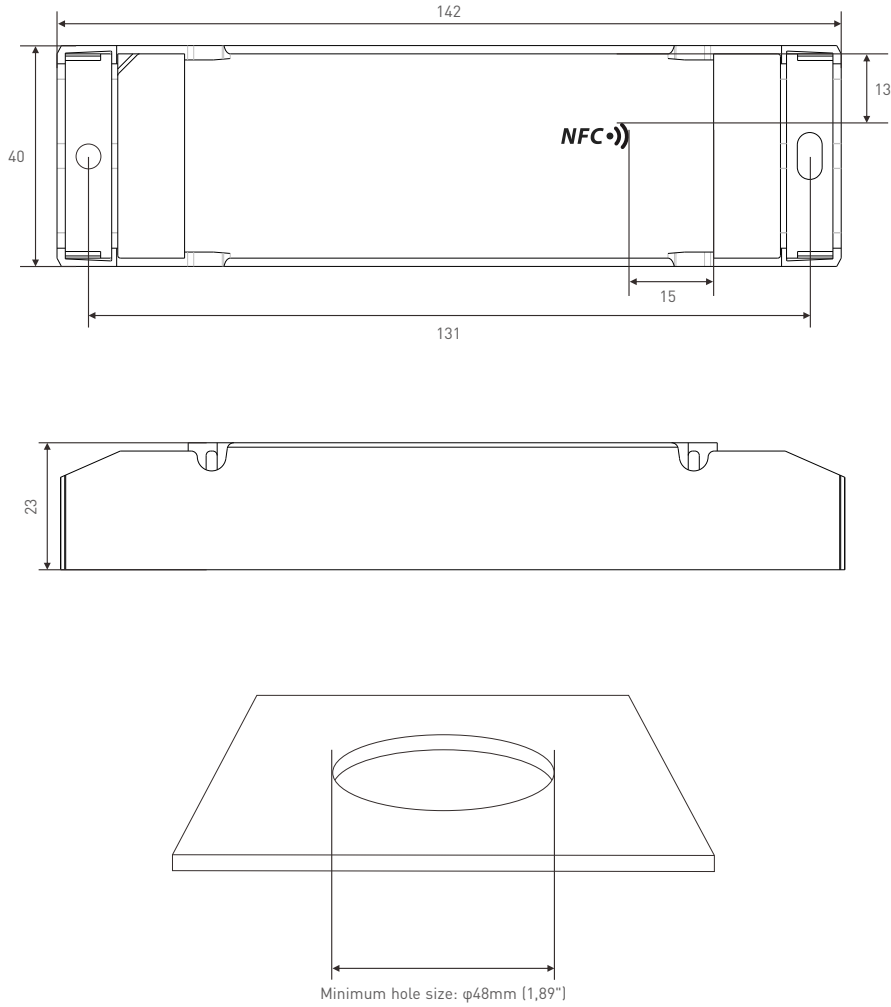

Wiring Diagram

DALI Connection

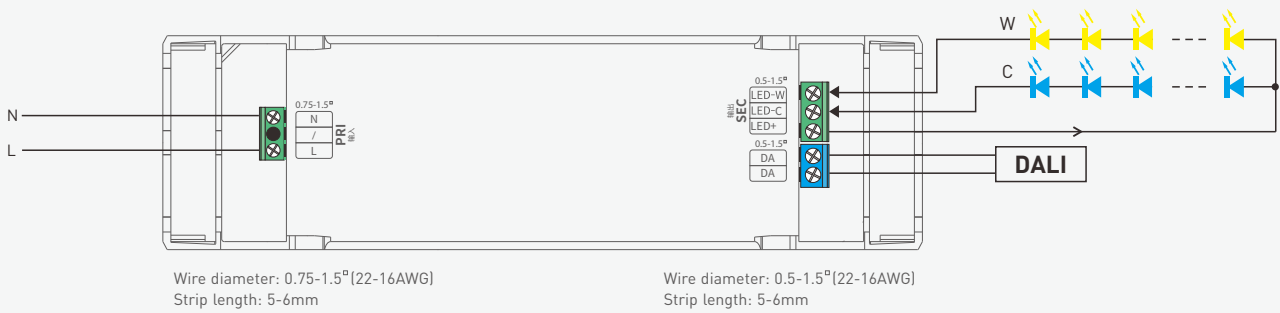

Dimming: 0-100%
Color temperature: 1000-10000K

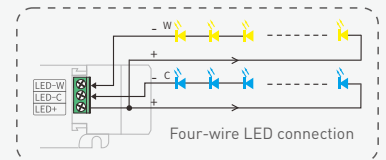

* Adopting constant power program design, it keeps the same brightness in color temperature dimming, and twice the rated power load can be connected.
e.g. A 40W driver can connect to 40W X 2CH load, but the total power of the 2 channels will be kept in 40W

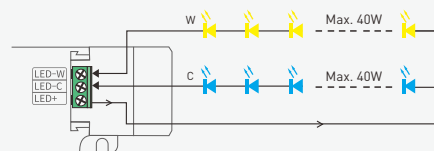

Table of Typical Corresponding Parameters for Current

The typical 16 current data sets below are for reference when selecting LED fixture models. More current levels can be set by NFC using mobile APP with 300-1050mA adjustable in 1mA step

SE-40-300-1050-W2D	Output Current	300mA	350mA	400mA	450mA	500mA	550mA	600mA	650mA
	Output Voltage	9-42Vdc	9-42Vdc	9-42Vdc	9-42Vdc	9-42Vdc	9-42Vdc	9-42Vdc	9-42Vdc
	Output Power	2.7-12.6W	3.15-14.7W	3.6-16.8W	4.05-18.9W	4.5-21W	4.95-23.1W	5.4-25.2W	5.85-27.3W
	Output Current	700mA	750mA	800mA	850mA	900mA	950mA	1000mA	1050mA
	Output Voltage	9-42Vdc	9-42Vdc	9-42Vdc	9-42Vdc	9-42Vdc	9-42Vdc	9-40Vdc	9-38Vdc
	Output Power	6.3-29.4W	6.75-31.5W	7.2-33.6W	7.65-35.7W	8.1-37.8W	8.54-39.9W	9-40W	9.45-40W

The typical 13 current data sets below are for reference when selecting LED fixture models. More current levels can be set by NFC using mobile APP with 200-800mA adjustable in 1mA step

SE-30-200-800-W2D	Output Current	200mA	250mA	300mA	350mA	400mA	450mA	500mA	550mA
	Output Voltage	9-42Vdc	9-42Vdc	9-42Vdc	9-42Vdc	9-42Vdc	9-42Vdc	9-42Vdc	9-42Vdc
	Output Power	1.8-8.4W	2.25-10.5W	2.7-12.6W	3.15-14.7W	3.6-16.8W	4.05-18.9W	4.5-21W	4.95-23.1W
	Output Current	600mA	650mA	700mA	750mA	800mA	/	/	/
	Output Voltage	9-42Vdc	9-42Vdc	9-42Vdc	9-40Vdc	9-37.5Vdc	/	/	/
	Output Power	5.4-25.2W	5.85-27.3W	6.3-29.4W	6.75-30W	7.2-30W	/	/	/

Application Diagram of Protective Cover

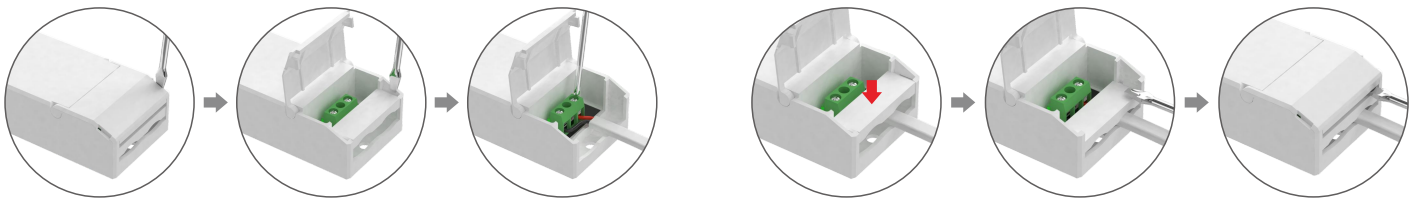

1. Put the head of a screwdriver on the side of the housing to pry up both the protective cover and wire fixing board. Then remove the wire fixing board and connect to the wires as wiring diagram shows.

2. Install the wire fixing board and press it down. Then snap on the protective cover while pressing the wire fixing board with a small flat-head screwdriver

Installation Precautions

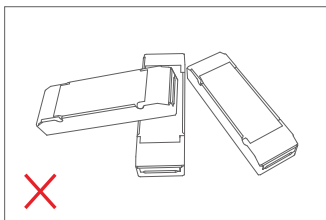

Please do not stack the products. The distance between two products should be $\geq 15\text{cm}$ so as not to affect heat dissipation or the lifetime of the products.

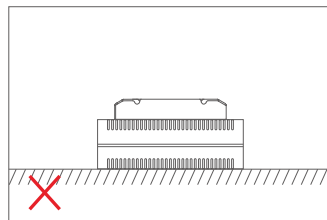
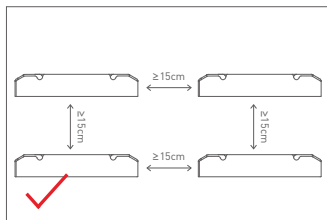

Please not place the products on power supplies. The distance between the product and the power supplies should be $\geq 15\text{cm}$ so as not to affect heat dissipation or shorten the lifetime of the products.

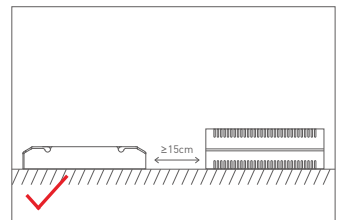

Note: The temperature within the installation area should be within the working temperature range of the products. Please do not install products inside LED fixtures to avoid temperature exceeding the working temperature that may affect the product lifetime.

Use the NFC Lighting APP

Scan the QR code below with your mobile phone and follow the prompts to complete the APP installation (According to performance requirements, you need to use a NFC-capable Android phone, or an iPhone 8 and later that are compatible with iOS 13 or higher).



* Before you begin setting the parameters of the driver, please make sure the driver is powered off.

Read/Write the LED driver

Use your NFC-capable phone to read LED driver data, then edit the parameters and they can be directly written to the driver.

1. Read the LED driver

On the APP home page, click [Read/Write LED driver], then keep the programmer's sensing area close to the NFC logo of the driver to read the driver parameters.



2. Switch the dimming interface

On the page of "Edit parameters", click [Dimming interfaces] to switch to the needed dimming interface: DT8 CT (DT8 1 channel), DT6 CT (DT6 2 channels), DT6 DIM (1 address for 1 channel / 1 address for 2 channels / 2 addresses for 2 channels).

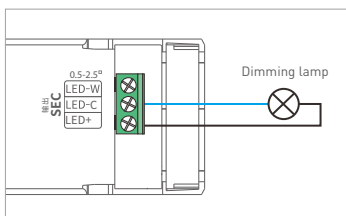

1 address for 1 channel

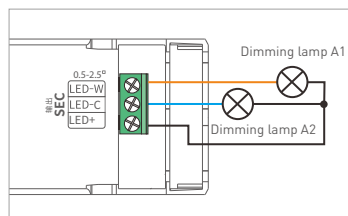

1 address for 2 channels

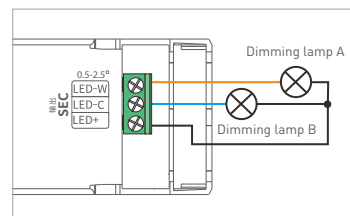

2 addresses for 2 channels

3. Edit the parameters

Click [Parameter settings] to edit the advanced parameters, like output current, DALI address, dimming curve, advanced DALI template, etc.

4. Write to the driver

After completing the parameter settings, click [Write] in the upper right corner, and keep the programmer's sensing area close to the NFC logo of the driver, so the parameters can be written to the driver.

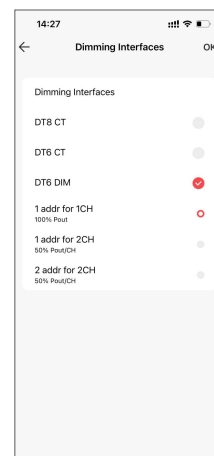
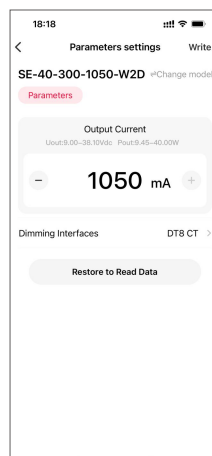
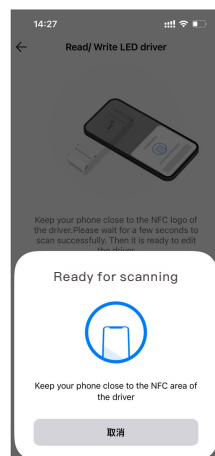
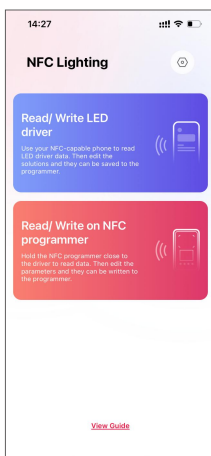

Advanced DALI template

Integrate the functions of the DALI lighting system, edit the DALI group and lighting effects for scenes, then save them in the advanced template to achieve lighting programming. Setup page (for Read/Write LED driver) : Go to App home page — [⊙] icon in the top right — [DALI template on phone] .

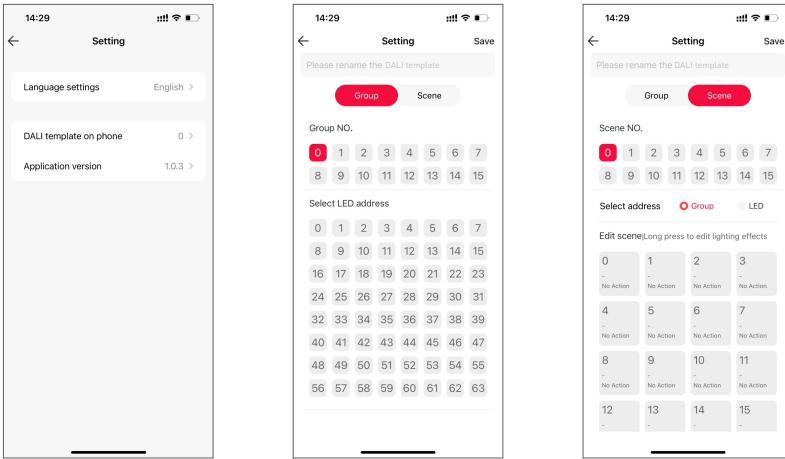

Relationship Diagrams

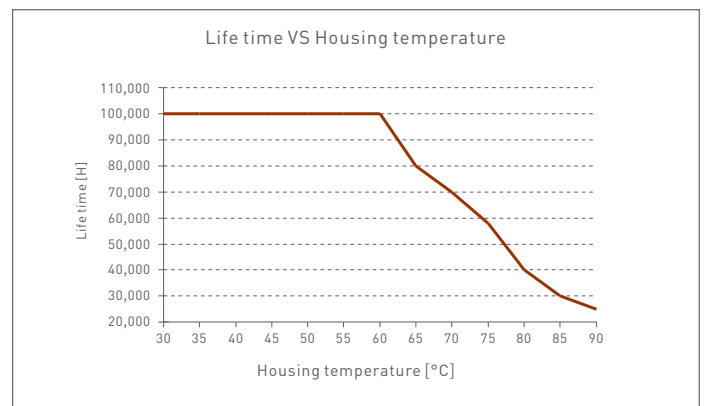
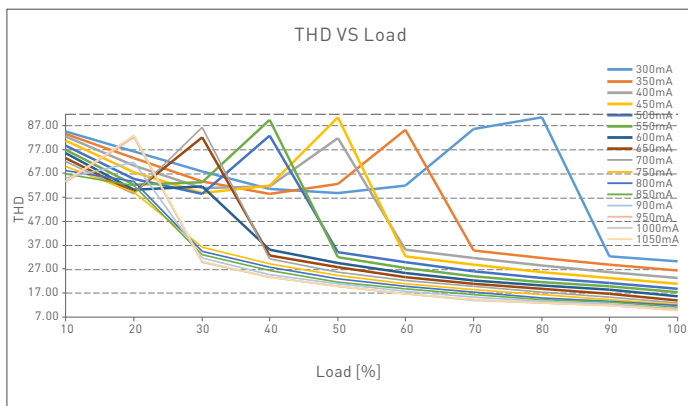
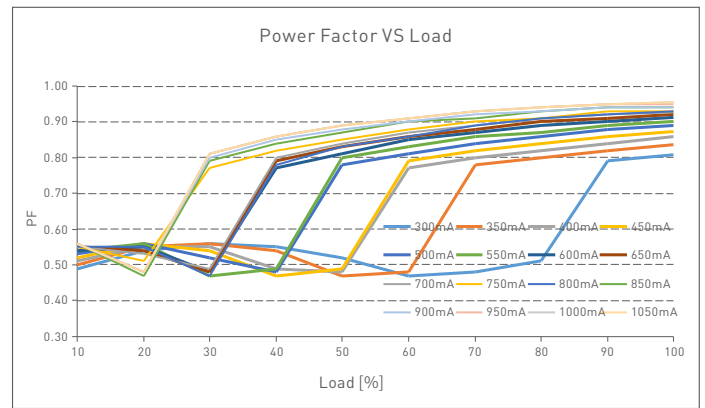
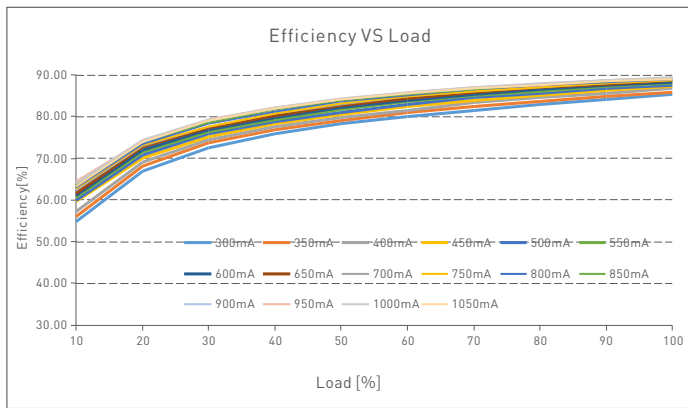

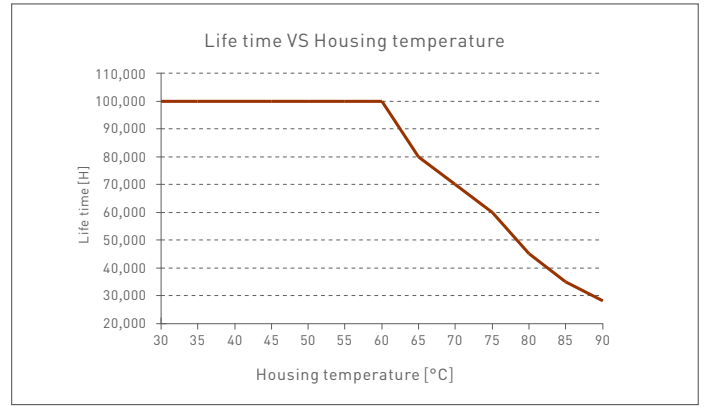
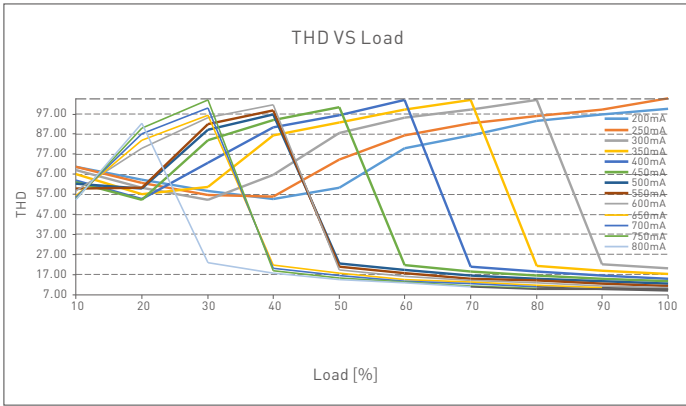
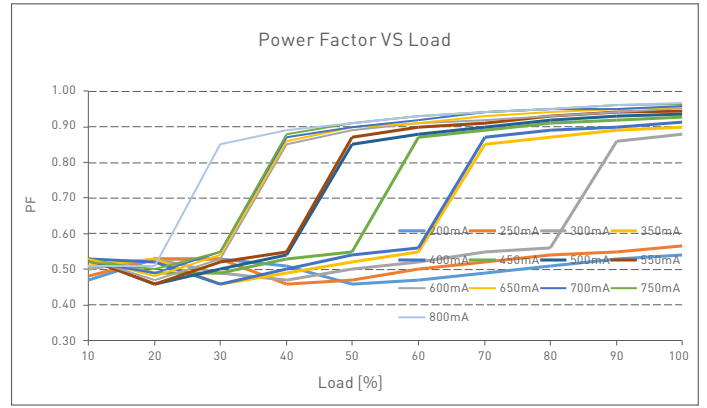
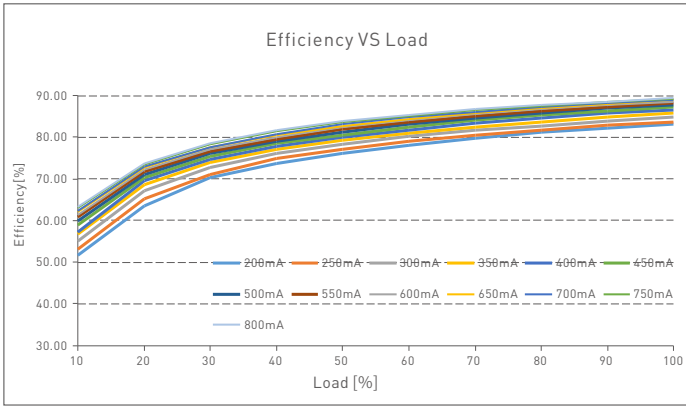

SE-30-200-800-W2D

Flicker Test Sheet

Limit of modulation in low risk area	
Waveform frequency of optical output	limit (%)
$f \leq 8\text{Hz}$	0.2
$8\text{Hz} < f \leq 90\text{Hz}$	$0.025 \times f$
$90\text{Hz} < f \leq 1250\text{Hz}$	$0.08 \times f$
$f > 1250\text{Hz}$	Exemption assessment
Limit of modulation in no effect area	
Waveform frequency of optical output	limit (%)
$f \leq 10\text{Hz}$	0.1
$10\text{Hz} < f \leq 90\text{Hz}$	$0.01 \times f$
$90\text{Hz} < f \leq 3125\text{Hz}$	$[0.08/2.5] \times f$
$f > 3125\text{Hz}$	Exemption assessment (High frequency exemption)

- Brightness
- ▲ 0.1%
 - ◆ 1%
 - ▲ 5%
 - ◆ 10%
 - 20%
 - ▲ 30%
 - 40%
 - ★ 50%
 - 60%
 - 70%
 - ◆ 80%
 - ★ 90%
 - ◆ 100%

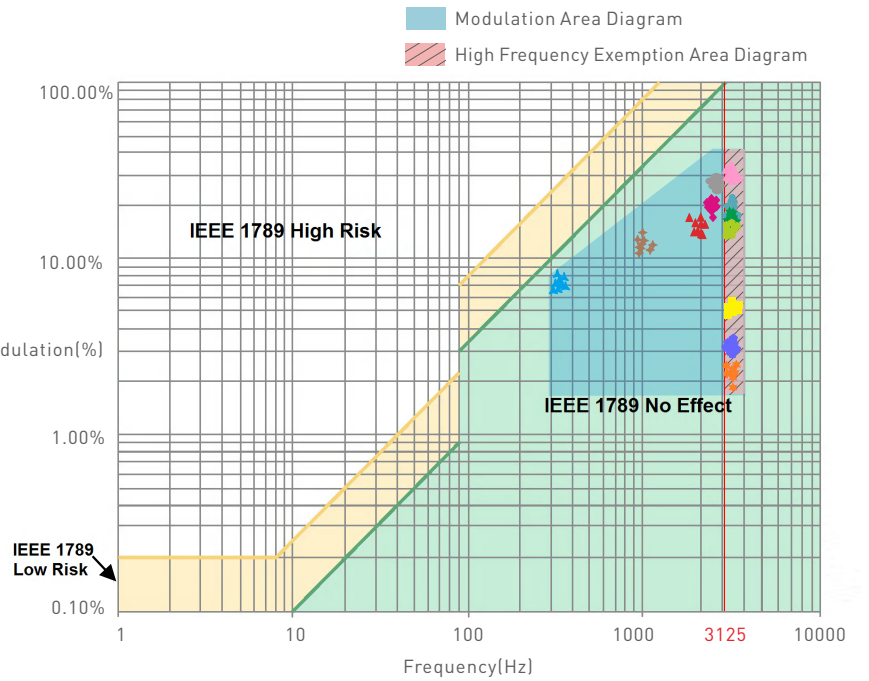

Marks in the right chart were tested results of different current ranges. The output frequency is 0Hz in 100% brightness and its corresponding modulation is 0%, which could not be shown in the right chart.

Packaging Specifications

Model	SE-40-300-1050-W2D	SE-30-200-800-W2D
Carton Dimensions	320×275×106mm(L×W×H)	320×275×106mm(L×W×H)
Quantity	20 PCS/Layer; 2 Layers/Carton; 40 PCS/Carton	20 PCS/Layer; 2 Layers/Carton; 40 PCS/Carton
Weight	0.17 kg/PC; 7.6 kg±5%/Carton	0.15 kg/PC; 6.8 kg±5%/Carton

Packaging Image

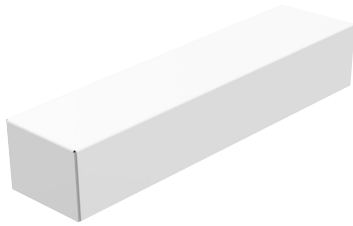

Inner Packaging Box



Carton Packaging

Transportation and Storage

1. Transportation

Products can be shipped via vehicles, boats and planes.

During transportation, products should be protected from rain and sun. Please avoid severe shock and vibration during the loading and unloading process.

2. Storage

The storage conditions should comply with the Class I Environmental Standards. The products that have been stored for more than six months are recommended to be re-inspected and can be used only after they have been qualified.

Attentions

- Products shall be installed by qualified professionals.
- LTECH products are and not lightningproof non-waterproof (special models excepted). Please avoid the sun and rain. When installed outdoors, please ensure they are mounted in a water proof enclosure or in an area equipped with lightning protection devices.
- Good heat dissipation will prolong the working life of products. Please ensure good ventilation.
- Please check if the working voltage used complies with the parameter requirements of products.
- The diameter of wire used must be able to load the light fixtures you connect and ensure the firm wiring.
- Before you power on products, please make sure all the wiring is correct in case of incorrect connection that causes damage to light fixtures.
- If a fault occurs, please do not attempt to fix products by yourself. If you have any question, please contact your suppliers.

* This manual is subject to changes without further notice. Product functions depend on the goods. Please feel free to contact our official distributors if you have any question.

Warranty Agreement

- Warranty periods from the date of delivery: 5 years.
- Free repair or replacement services for quality problems are provided within warranty periods.

Warranty exclusions below:

- Beyond warranty periods.
- Any artificial damage caused by high voltage, overload, or improper operations.
- Products with severe physical damage.
- Damage caused by natural disasters and force majeure.
- Warranty labels and barcodes have been damaged.
- No any contract signed by LTECH.

1. Repair or replacement provided is the only remedy for customers. LTECH is not liable for any incidental or consequential damage unless it is within the law.
2. LTECH has the right to amend or adjust the terms of this warranty, and release in written form shall prevail.

FCC Radiation Exposure Statement

This equipment complies with FCC radiation exposure limits set forth for an uncontrolled environment. This equipment should be installed and operated with minimum distance 20cm between the radiator & your body.

FCC Warning

This device complies with Part 15 of the FCC Rules. Operation is subject to the following two conditions:

(1) This device may not cause harmful interference, and (2) this device must accept any interference received, including interference that may cause undesired operation.

NOTE 1: This equipment has been tested and found to comply with the limits for a Class B digital device, pursuant to part 15 of the FCC Rules. These limits are designed to provide reasonable protection against harmful interference in a residential installation. This equipment generates uses and can radiate radio frequency energy and, if not installed and used in accordance with the instructions, may cause harmful interference to radio communications. However, there is no guarantee that interference will not occur in a particular installation. If this equipment does cause harmful interference to radio or television reception, which can be determined by turning the equipment off and on, the user is encouraged to try to correct the interference by one or more of the following measures:

- Reorient or relocate the receiving antenna.
- Increase the separation between the equipment and receiver.
- Connect the equipment into an outlet on a circuit different from that to which the receiver is connected.
- Consult the dealer or an experienced radio/TV technician for help.

NOTE 2: Any changes or modifications to this unit not expressly approved by the party responsible for compliance could void the user's authority to operate the equipment.

Update Log

Version	Updated Time	Update Content	Updated by
A0	2022.10.09	Original version	Liu Weili
A1	2023.07.28	Remove the description of the NFC programmer	Liu Weili