

## Intelligent Tunable White LED Driver (Constant Voltage)

- The housing is made from V0 flame retardant PC materials from SAMSUNG/COVESTRO.
- The clamshell design and screwless type for strain-relief. The design of dismountable end cap allows you to adjust the length of housing depending on your needs.
- Change the DALI address, PWM frequency and other parameters via the APP.
- Set the DALI group and scene in the advanced DALI template via the APP.
- Adopt constant power design that can adjust different color temperature while brightness remains the same.
- With soft-on and fade-in dimming function, enhancing your visual comfort.
- The whole dimming process is flicker-free with high frequency exemption level.
- T-PWM™ super deep dimming technology, 0.01% dimming depth.
- Comply with the EU's ErP Directive, networked standby<0.5W.
- Overheat, over voltage, overload, short circuit protection and automatic recovery.
- Normal service life can reach 100,000 hours.
- 5-year warranty (Rubycon capacitor).



**T-PWM™**  
Dimming Technology

**Flicker Free**  
IEEE 1789



Dimmable:  
10000 : 1



The certification icon represents undergoing certification applications only, and final certification qualification subject to actual product.



## Technical Specs

Model		LM-240-24-G2D2		
Features	Output Type	Constant voltage		
	Dimming Interface	DALI-2 DT6/DT8, PUSH DIM/CCT		
	Output Feature	Isolation		
	Protection Grade	IP20		
	Insulation Grade	Class II (Suitable for class I/ II /III light fixtures)		
OUTPUT	Output Voltage	24Vdc		
	Output Voltage Range	24Vdc±0.5Vdc		
	Output Current	Max. 10A		
	Output Power	Max. 240W		
	Dimming Range	0~100%, down to 0.01%		
	Ripple(maximum)	200mVp-p		
	Voltage Accuracy	±5%		
	PWM Frequency	3600Hz [Default] / (NFC setting range 300-22000Hz)		
INPUT	DC Voltage Range	200-250Vdc		
	AC Voltage Range	220-240Vac		
	EoFv	99.6%		
	Input Voltage	220-240Vac		
	Frequency	50/60Hz		
	Input Current	Max. 1.18A/230Vac		
	Power Factor	PF>0.99/230Vac, at full load		
	THD	THD≤5%@230Vac, at full load		
	Efficiency [Typ.]	94%		
	Inrush Current	Cold start 55A[Test twidth=1200us tested under 50% Ipeak]/230Vac		
Anti Surge	L-N: 2KV			
Leakage Current	Max. 0.5mA			
ENVIRONMENT	Working Temperature	ta: -20 ~ 45°C tc: 86°C		
	Working Humidity	20 ~ 95%RH, non-condensing		
	Storage Temperature/Humidity	-40 ~ 80°C/10-95%RH		
	Temperature Coefficient	±0.03%/°C[0-50°C]		
	Vibration	10-500Hz, 2G 12min/1cycle, 72 min for X, Y and Z axes respectively		
PROTECTION	Overload Protection	Shut down the output when rated power≥102%, auto recovers		
	Overheat Protection	Intelligently adjust or turn off the output current if the PCB temperature ≥110°C, and recover automatically		
	Overvoltage Protection	Shut down the output when voltage≥28V, and recover automatically		
	Short Circuit Protection	Enter hiccup mode if short circuit occurs, and recover automatically		
SAFETY & EMC	Withstand Voltage	I/P-O/P: 3750Vac		
	Insulation Resistance	I/P-O/P: 100MΩ/500VDC/25°C/70%RH		
	Safety Standards	CCC	China	GB19510.1, GB19510.14
		TUV	Germany	EN61347-1, EN61347-2-13, EN62493
		CB	CB Member States	IEC61347-1, IEC61347-2-13
		CE	European Union	EN61347-1, EN61347-2-13, EN62384
		KC	Korea	KC61347-1, KC61347-2-13
		EAC	Russia	IEC61347-1, IEC61347-2-13
		RCM	Australia	AS 61347-1, AS 61347-2-13
		ENEC	Europe	EN61347-1, EN61347-2-13, EN62384
		UKCA	Britain	BS EN 61347-1, BS EN 61347-2-13, BS EN 62493
	EMC Emission	CCC	China	GB/T17743, GB17625.1
		CE	European Union	EN55015, EN61000-3-2, EN61000-3-3, EN61547
		KC	Korea	KSC 9815, KSC 9547
		EAC	Russia	IEC62493, IEC61547, EH55015
RCM		Australia	EN55015, EN61000-3-2, EN61000-3-3, EN61547	
UKCA		Britain	BS EN IEC 55015, BS EN IEC 61000-3-2, BS EN 61000-3-3, BS EN 61547	
EMC Immunity	EN61000-4-2,3,4,5,6,8,11, EN61547			
ErP	Power Consumption	Networked standby	<0.5W (After shutdown by command)	
		No-load power consumption	<0.5W (When the lamp is not connected)	
	Flicker/Stroboscopic Effect	IEEE 1789	Meet IEEE 1789 standard/High frequency exemption level	
		CIE SVM	Pst LM≤1.0, SVM≤0.4	
OTHERS	DF	Phase factor	DF≥0.9	
	Weight[N.W.]	555g±10g		
Dimensions	380×49.5×30mm[L×W×H]			

The driver is suitable for connecting resistor current-limiting LED fixture (e.g. LED strip). The inrush current will be dozens of times increased if connecting built-in constant current IC current-limiting LED fixtures, the driver will activate the overloaded protection (hiccup flickering). When you order, please remark controlling the constant current LED fixture (e.g. MR16 lamp, underground light, LED wall washer, constant current LED strip, etc.), so that we can prepare them with special procedures.

Product Size

Unit: mm

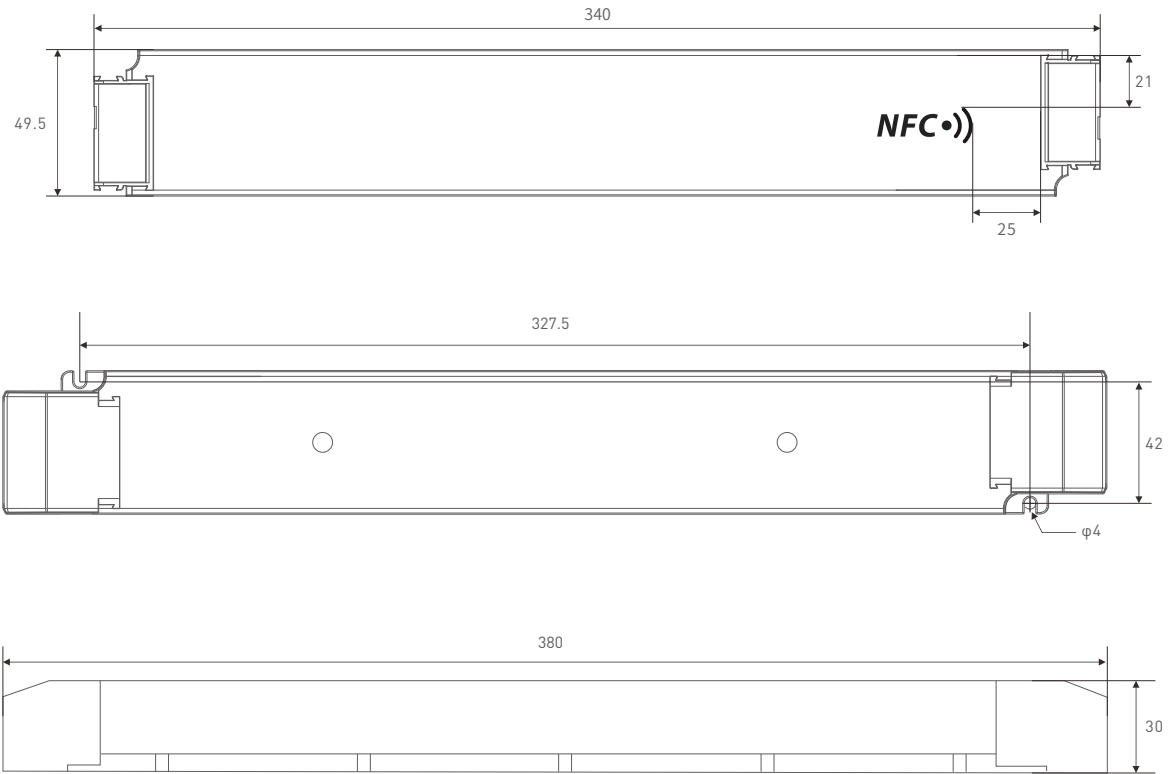

Wiring Diagram

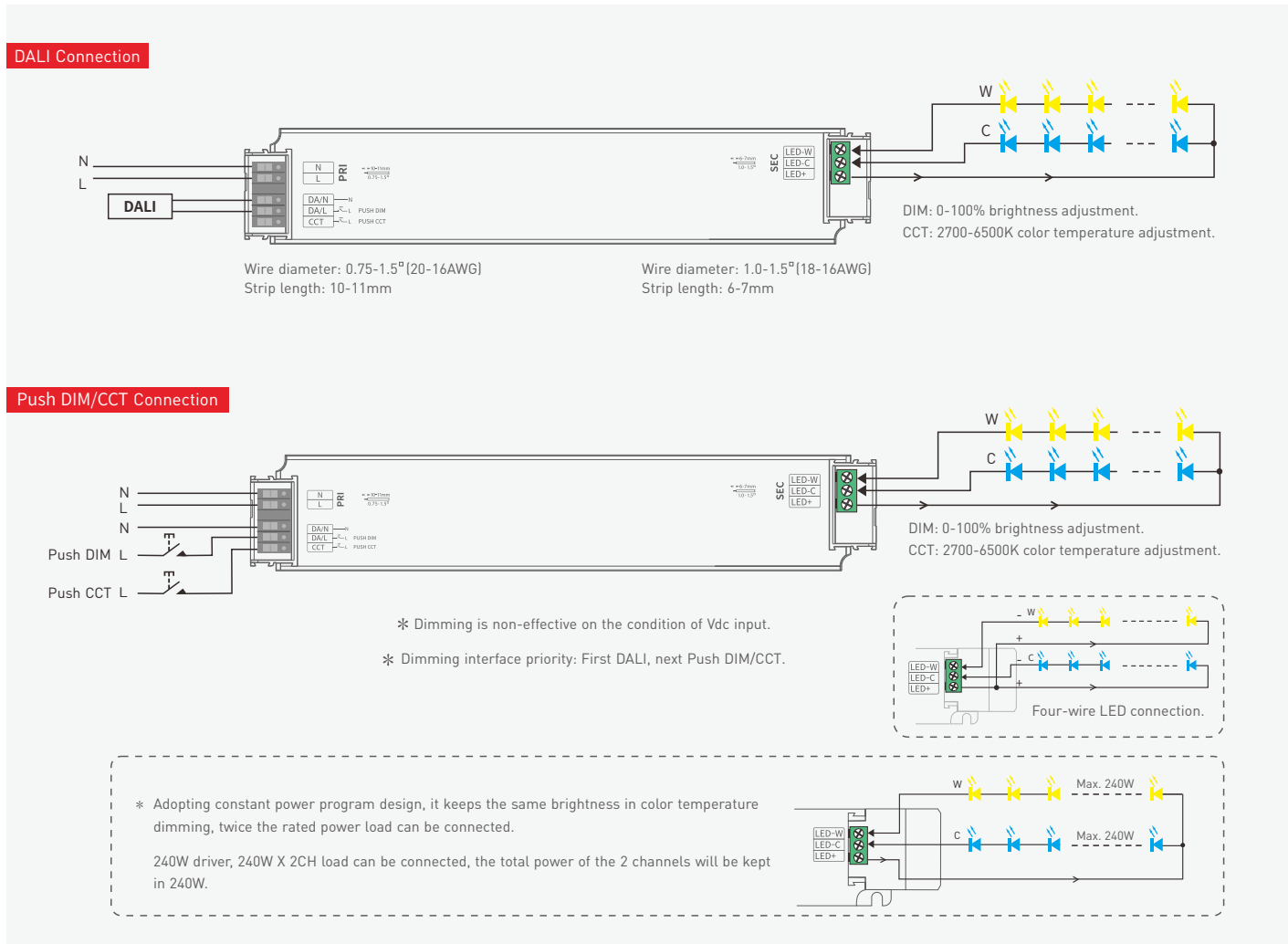

## Push DIM/CCT



Reset switch

- On/off control: Short press.
- Stepless dimming: Long press.
- With every other long press, the brightness goes to the opposite direction.
- Dimming memory: Brightness will be the same as previously adjusted when turning on again.

## Protective Housing Application Diagram

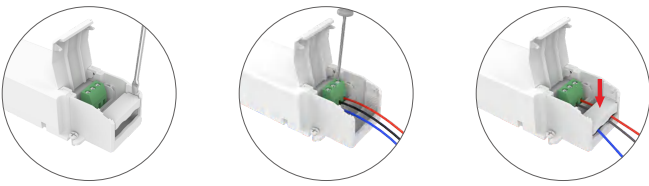

Use a screwdriver to pry up the protective housing at the edge of the wire fixing board. Then connect to the wires as the diagram shows and press down the wire fixing board.



Press down the back side of the protective housing and move it from side to side to remove it.

## Installation Precautions

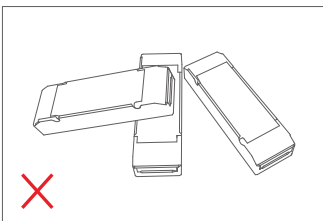

Please do not stack the products. The distance between two products should be  $\geq 15\text{cm}$  so as not to affect heat dissipation and the lifespan of the products.

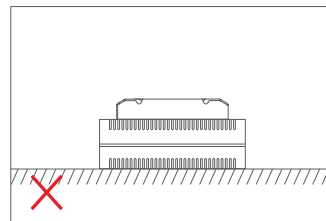
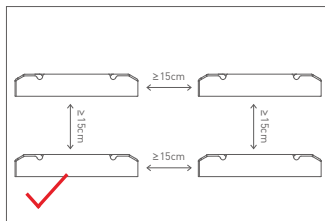

Please not place the products on LED drivers. The distance between the product and the driver should be  $\geq 15\text{cm}$  so as not to affect heat dissipation and shorten the lifespan of the products.

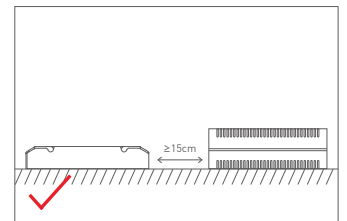

Note: The temperature within the installation area should be within the working temperature range of the products. Please do not install products inside LED fixtures to avoid temperature exceeding the working temperature that may affect the product lifetime.

## Use the NFC Lighting APP

Scan the QR code below with your mobile phone and follow the prompts to complete the APP installation (According to performance requirements, you need to use a NFC-capable Android phone, or an iPhone 8 and later that are compatible with iOS 13 or higher).



\* Before you begin setting the parameters of the driver, please make sure the driver is powered off.

### Read/Write the LED driver

Use your NFC-capable phone to read LED driver data, then edit the parameters and they can be directly written to the driver.

#### 1. Read the LED driver

On the APP home page, click [Read/Write LED driver], then keep the programmer's sensing area close to the NFC logo of the driver to read the driver parameters.

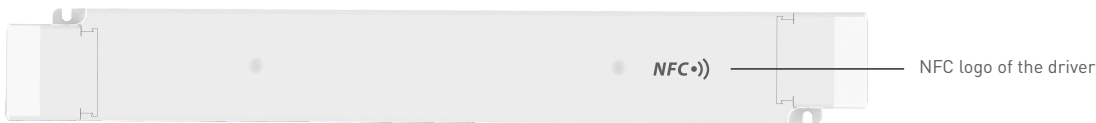

#### 2. Switch the dimming interface

On the page of "Edit parameters", click [Dimming interfaces] to switch to the needed dimming interface: DT8 CT (DT8 1 channel), DT6 CT (DT6 2 channels), DT6 DIM (1 address for 1 channel / 1 address for 2 channels / 2 addresses for 2 channels).

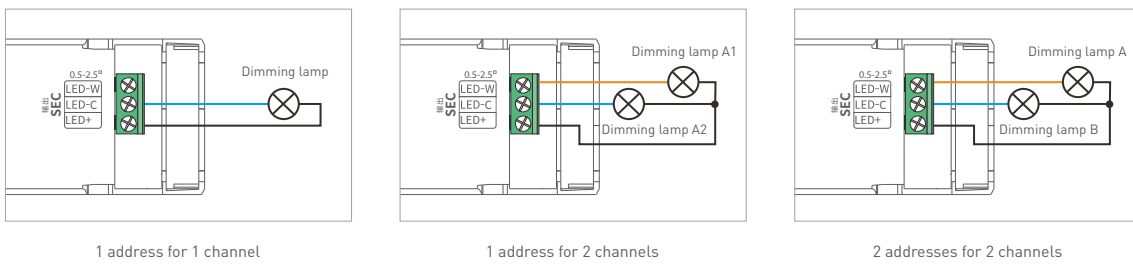

#### 3. Edit the parameters

Click [Parameter settings] to edit the advanced parameters, like DALI address, PWM frequency, dimming curve, advanced DALI template, etc.

#### 4. Write to the driver

After completing the parameter settings, click [Write] in the upper right corner, and keep the programmer's sensing area close to the NFC logo of the driver, so the parameters can be written to the driver.

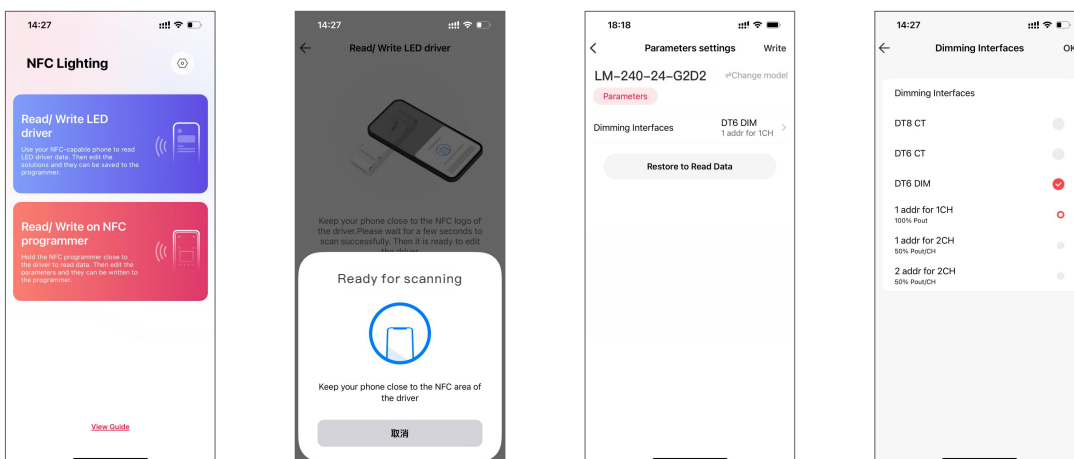

Advanced DALI template

Integrate the functions of the DALI lighting system, edit the DALI group and lighting effects for scenes, then save them in the advanced template to achieve lighting programming.

Setup page (for Read/Write LED driver) : Go to App home page — [⊙] icon in the top right — [DALI template on phone] .

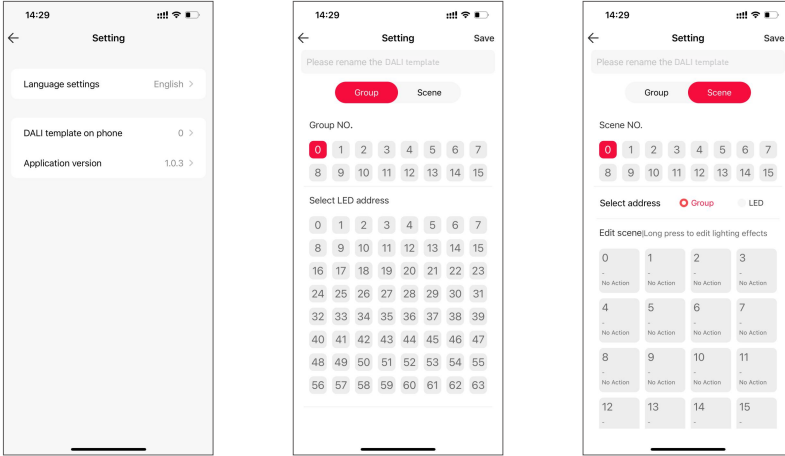

Relationship Diagrams

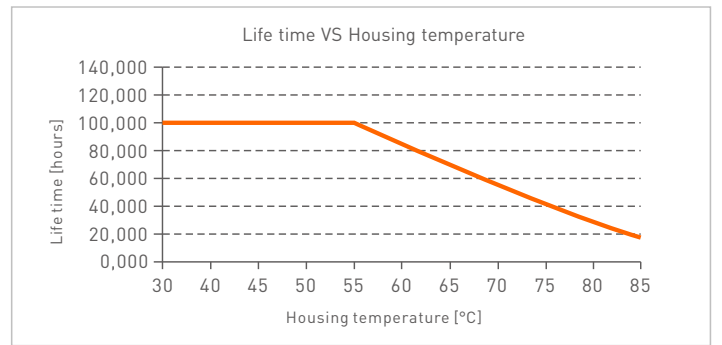
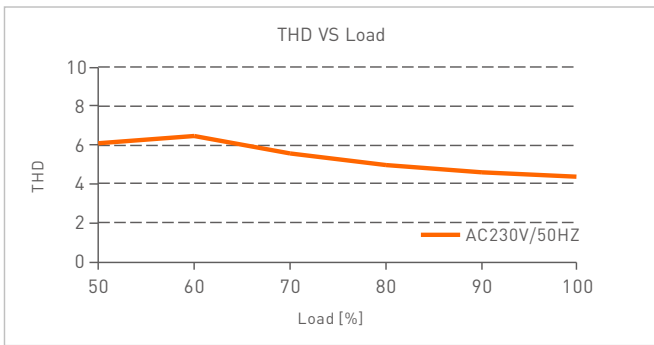
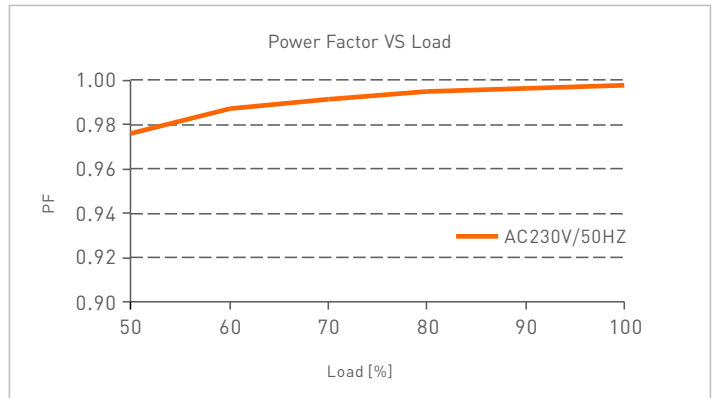
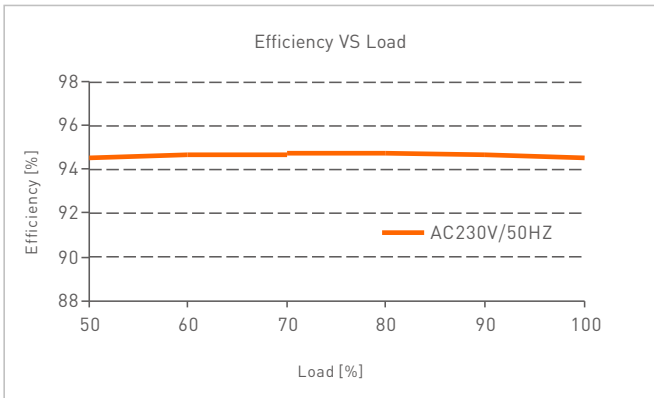

## Flicker Test Form

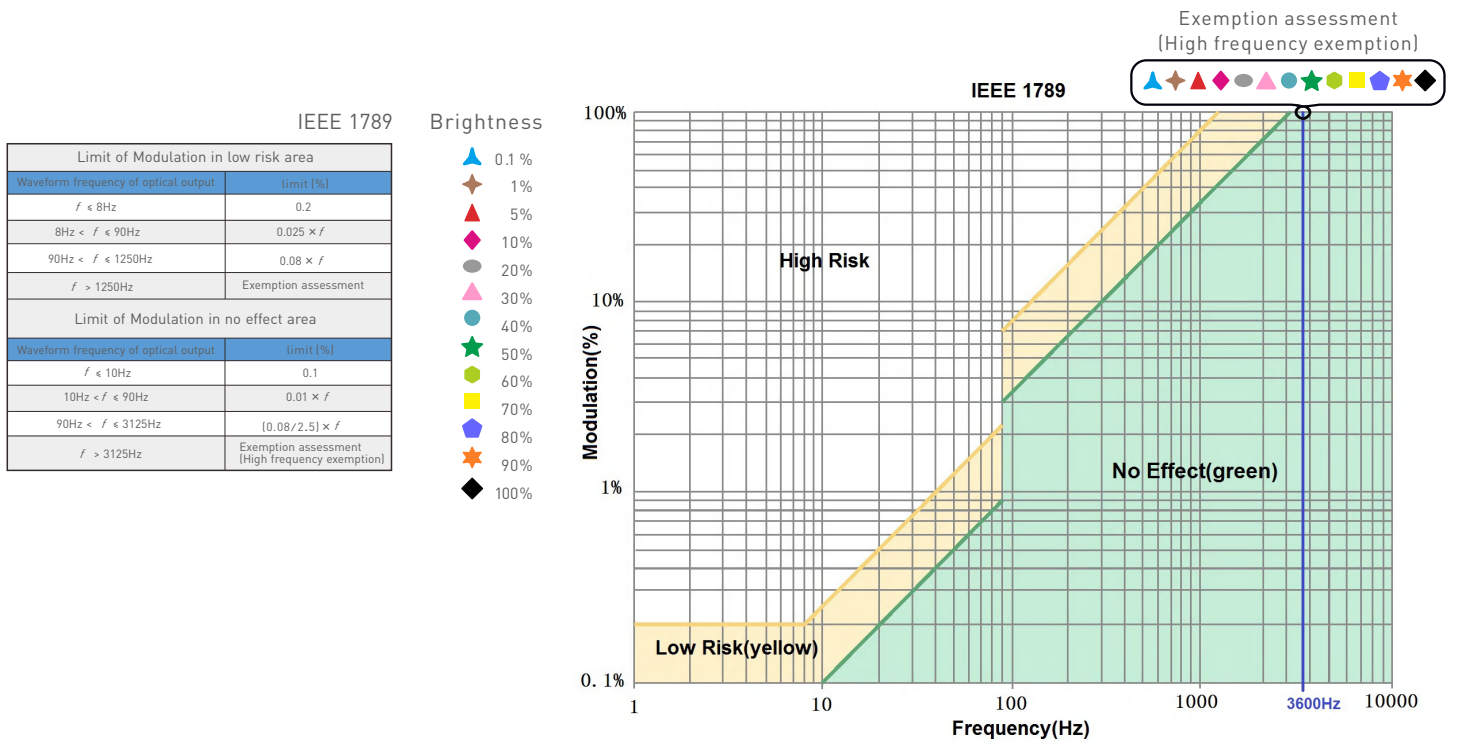

## Packaging Specifications

Model	LM-240-24-G2D2
Carton Dimensions	400×350×120mm(L×W×H)
Quantity	10 PCS/Layer; 2 Layers/Carton; 20 PCS/Carton
Weight	0.555 kg/PC; 12 kg±5%/Carton

## Packaging Image

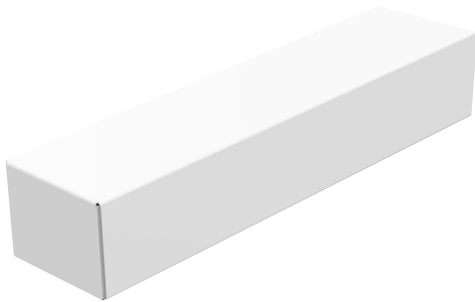

Inner Packaging Box



Carton Packaging

## Transportation and Storage

### 1. Transportation

Products can be shipped via vehicles, boats and planes.

During transportation, products should be protected from rain and sun. Please avoid severe shock and vibration during the loading and unloading process.

### 2. Storage

The storage conditions should comply with the Class I Environmental Standards. The products that have been stored for more than six months are recommended to be re-inspected and can be used only after they have been qualified.

## Attentions

- Products shall be installed by qualified professionals.
- LTECH products are and not lightningproof non-waterproof (special models excepted). Please avoid the sun and rain. When installed outdoors, please ensure they are mounted in a water proof enclosure or in an area equipped with lightning protection devices.
- Good heat dissipation will prolong the working life of products. Please ensure good ventilation.
- Please check if the working voltage used complies with the parameter requirements of products.
- The diameter of wire used must be able to load the light fixtures you connect and ensure the firm wiring.
- Before you power on products, please make sure all the wiring is correct in case of incorrect connection that causes damage to light fixtures.
- If a fault occurs, please do not attempt to fix products by yourself. If you have any question, please contact your suppliers.

\* This manual is subject to changes without further notice. Product functions depend on the goods. Please feel free to contact our official distributors if you have any question.

## Warranty Agreement

- Warranty periods from the date of delivery: 5 years.
- Free repair or replacement services for quality problems are provided within warranty periods.

Warranty exclusions below:

- Beyond warranty periods.
- Any artificial damage caused by high voltage, overload, or improper operations.
- Products with severe physical damage.
- Damage caused by natural disasters and force majeure.
- Warranty labels and barcodes have been damaged.
- No any contract signed by LTECH.

1. Repair or replacement provided is the only remedy for customers. LTECH is not liable for any incidental or consequential damage unless it is within the law.
2. LTECH has the right to amend or adjust the terms of this warranty, and release in written form shall prevail.

**Update Log**

Version	Updated Time	Update Content	Updated by
A0	2023.02.15	Original version	Liu Weili
A1	2023.08.14	Remove the description of the NFC programmer	Liu Weili