

Constant current independent dimmable driver
DEL Series suffix d(DALI-2+PUSH)

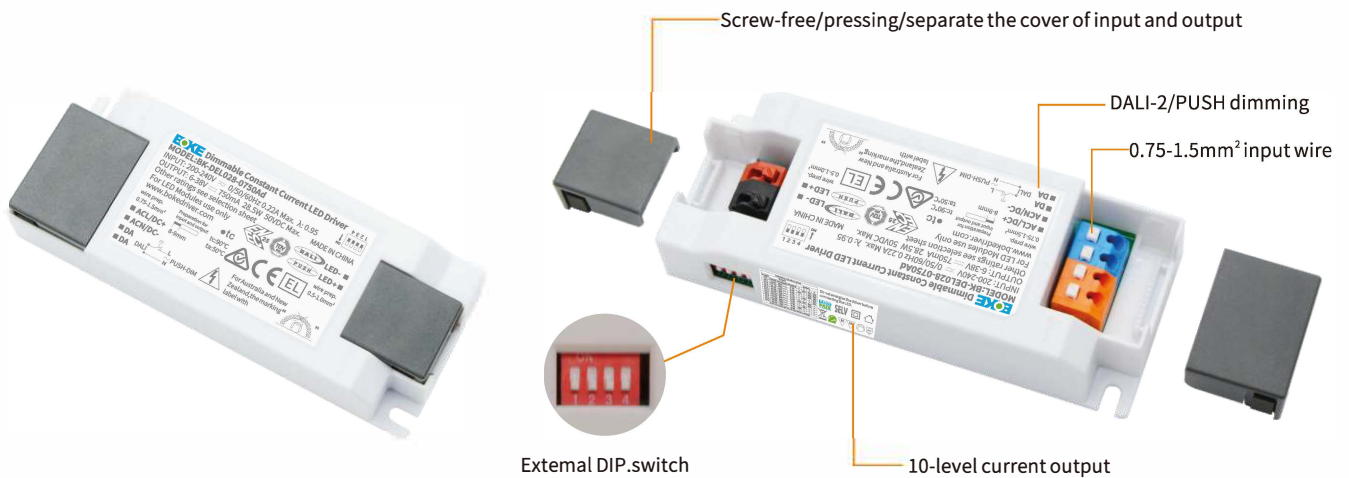

Features

- Support DALI-2+PUSH dimming mode
- 10-level current output can be realized by DIP-switch
- Soft dimming and flicker-free at any brightness
- Using HPC patented technology, at any dimming level, the current output between drivers is the same
- Dimming range 1~100%, output current accuracy 1%
- Standby power input < 0.5W, meets the requirements of ErP certification
- High PF, high efficiency, low THD
- Screw-free and pressing type strain relief, supports thicker cables and is easier to install
- Independent input and output strain relief, stronger wiring
- Intelligent LED hot-plug protection function
- SELV and Class II design, suitable for use inside of the light
- Passed ENEC-TUV, CE, RCM, CCC, DALI-2 and other certifications
- IP20 protection grade, indoor use
- Nominal life-time up to 100,000 h
- 5-year guarantee

Interfaces

- DALI-2(DALI-2DT6)
- PUSH(PUSH-DIM)

Functions

- Support central emergency application (dimming normal in DC input)
- Support self-contained emergency application
- Protective features (short-circuit, overload, no-load, hot plug-in protection)

Suitable for lights

- Suitable for lights with independent drivers such as downlights, spotlights, panel lights, etc
- Not suitable for lights with built-in drivers

Typical applications

- LED indoor lighting
- LED office lighting
- LED commercial lighting



Model coding rules of DEL series

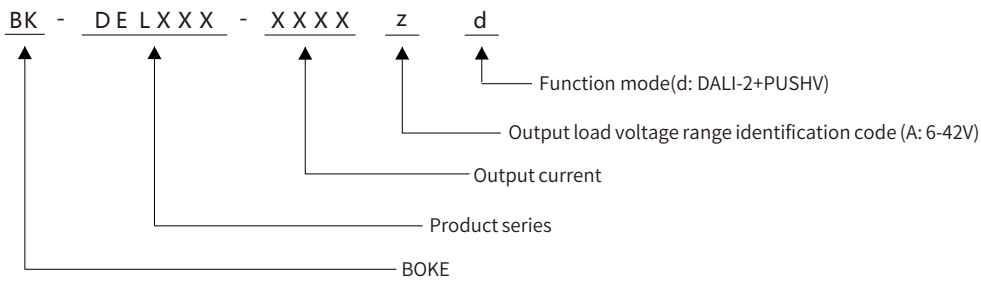

Order selection table of DEL series(just suffix d, 28W)

Model	Input voltage	Output power	Output voltage	Output current	Dimension	Article number
BK-DEL028-0750Ad	200-240VAC	28.5W	6-42VDC	0.30-0.75A	L117*W45.5*H29mm	B-DEL028-HA1001Ad

Technical data

Product model	BK-DEL028-0750Ad
Output parameters	
Regulation method	Constant Current
Rated output current	0.3-0.75A
Rated output voltage	6-42V
Rated output power	28.5W Max
Output current adjustment	DIP S.W(10 levels)
Output current ripple LF	±2%
Output current accuracy	±1%
Linear regulation	±1%
Load regulation	±1%
No load output voltage	50V
Flicker-free(typical)	Modulation depth =0.508% (100Hz), Pst LM = 0.005, SVM = 0.010,(The above parameters are obtained from testing the panel lights)
Input parameters	
Rated input voltage	200-240VAC 200-240VDC
Rated input voltage	180-264VAC 180-264VDC
Input voltage shock	<380 V AC, 1 h
Input current	<0.22A (AC input)
Input frequency	47-63Hz
Input power factor	>0.95 (230V AC & Full load)
Input THD	<10% (230V AC & Full load)
Efficiency(typical)	86% (230V AC & Full load)
In-rush current	6.5A peak ,194us duration(50 % Ipeak), see the description below for details
Start/Switchover/Turn off	<0.6s(AC start),<0.6s(DC start),<0.3s(AC/DC switchover),<0.5s(Turn off)
Switching cycles	> 50,000 switching cycles
Power consumption	Full load(Pmax):28.5W, No load(Pno): N/A, On stand-by(Psb) : <0.5W, Network stand-by(Pnet) : N/A
Safety	
Withstand voltage	I/P-O/P:3750V AC, I/P-DALI: 500V AC.
Mains surge capability	L-N:2KV
Leakage current	<0.7mA (230V AC & Full load)
Isolation resistance	I/P-O/P:100MΩ/500Vdc/25°C/70% RH
Control interface	
DALI dimming port	Voltage range: 9.5-22.5V, typical 16V, interface current consumption: 1.8mA
PUSH dimming port	Voltage range: 180-264V 47/63Hz
1-10V 3in1 dimming port	N/A
Auxiliary power supply	N/A
Dimming range	1-100%
Dimming drive mode	AM(amplitude modulation)
Emergency support	
Central emergency system	Supported(dimming normal in DC input)
Self-contained emergency	Supported
Environment & Life time	
Operating temperature	Ta=-20-45°C
Case temperature	Tc=90°C
Operating humidity	5-85% RH, not condensed
Storage temp./humidity	-40-80°C, 5-85% RH, not condensed
IP grade	IP20
MTBF	500,000H,MIL-HDBK-217F(25°C)
Life-time	Nominal life-time up to 100,000 h, see the description below for details
Vibration resistant	10~500Hz,5G 12min./1cycle,period for 72min. each along X,Y,Z axes
Acoustic Noise	<25dB(30cm, Full load)
Environmental protection	RoHS
Certifications and standards	
Certified	ENEC-TUV, RCM, EMC, CE, CCC, DALI-2
Safety	EN61347-1, EN61347-2-13, EN62384
EMC	EN55015, EN61000-3-2, EN61000-3-3, EN61000-4-2,3,4,5,6,8,11, EN61547
DALI-2	IEC 62386-101(DALI-2), IEC 62386-102(DALI-2), IEC 62386-207(DALI-2)
EL	Compatible IEC 61347-2- 13 Annex J, compatible with EN 60598-2-22 and EN 50172
RF	N/A

Remarks

- 1.By default, all parameter are measured at 230VAC input, full load and 25°C of ambient temperature.
- 2.The driver can not be installed inside the light. when the driver is used with the light, the EMC of the whole light needs to be tested.

Electrical values

BK-DEL028-0750Ad

Operating window

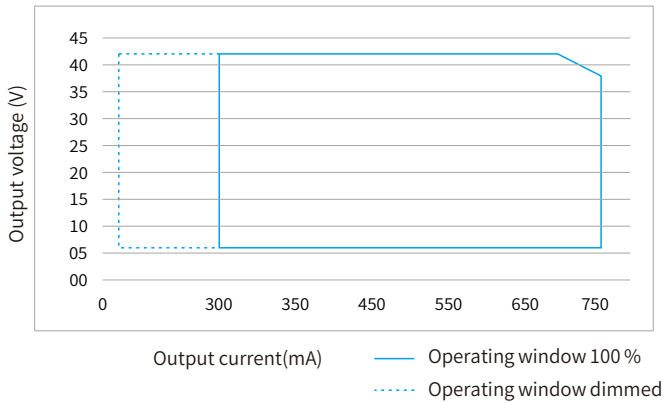

Operating window

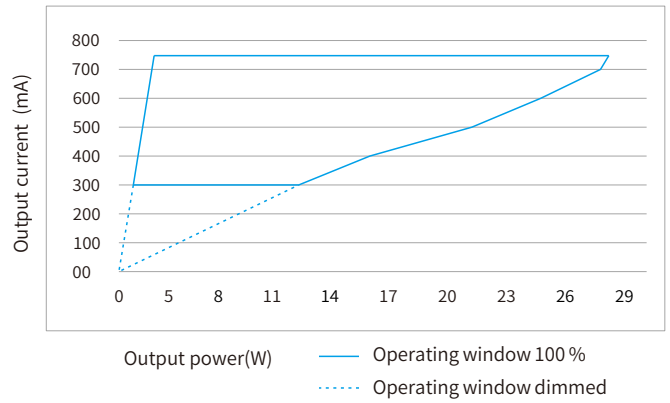

Efficiency vs load

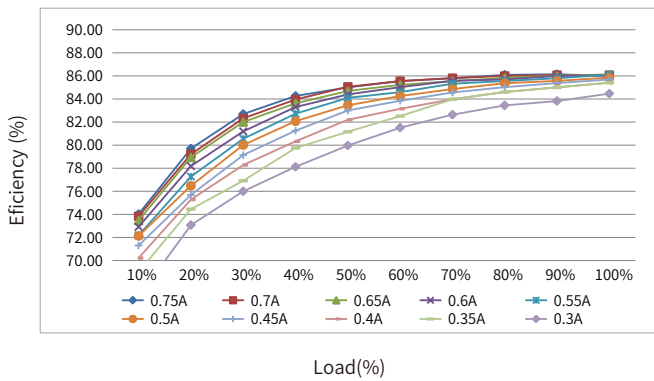

THD vs. Load

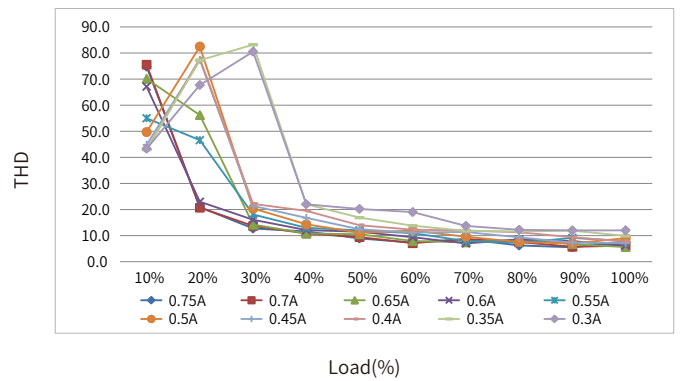

Power factor vs. Load

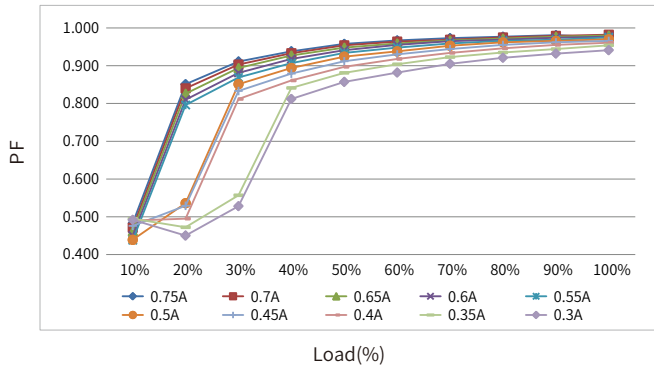

Expected life-time

Life-time vs. case temperature

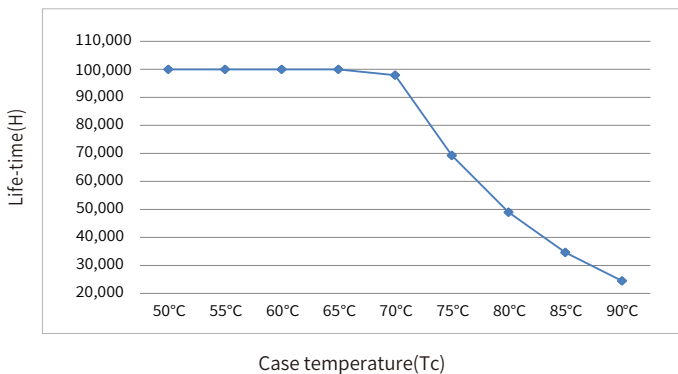

-The life-time of the LED driver is shown in the figure above (calculated based on the 90% survival rate).
 - The relation of tc to ta temperature depends also on the luminaire design.

Surge

Model	Ipeak	Twidth	Condition	Relative number of MCB														
				B10	B13	B16	B20	B25	C10	C13	C16	C20	C25	D10	D13	D16	D20	D25
BK-DEL028-0750Ad	6.5A	194us	AC 230V, Full load, Cold start, Ta ≤ 30°C, MCB is not installed side by side	48pcs	62pcs	77pcs	96pcs	120pcs	48pcs	62pcs	77pcs	96pcs	120pcs	48pcs	62pcs	77pcs	96pcs	120pcs

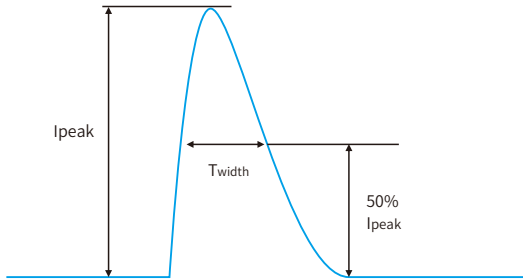

Remarks

- The number of drives mounted under different MCBs in the table is the maximum value. Please do not exceed this number during installation.
- Calculation uses typical values from ABB series S200 as a reference.
- Different brands and models of miniature circuit breakers, the number of drives mounted will be slightly different.
- If the ambient temperature of the MCB installation exceeds 30°C or multiple MCBs are installed side by side, the number of drives mounted will be reduced and the calculation needs to be recalculated.
- Electrician's usually consider Type B for household lighting and Type C for commercial lighting application.

Functions

Output short-circuit behaviour

- In case of a short-circuit at the LED output ,the LED output is switched off.
- After restart of the LED driver ,the output will be activated again.
- The restart can either be done via mains reset or via interface (DALI, PUSH-DIM).

Output no-load operation

- The LED driver will not be damaged in no-load operation.
- The output will be deactivated and is therefore free of voltage.
- If a LED load is connected , the device has to be restarted before the output will be activated again.
- The restart can either be done via mains reset or via interface (DALI, PUSH-DIM).

Output overload protection

- If the output voltage range is exceeded the LED driver turns off the LED output.
- After restart of the LED driver the output will be activated again.
- The restart can either be done via mains reset or via interface (DALI, PUSH-DIM).

Output hot plug-in

- For protection LED if plug the LED into the output of the powered driver, the LED will not on, the device has to be restarted.
- The restart can either be done via mains reset or via interface (DALI, PUSH-DIM).

BOKE Dimmable Constant Current LED Driver

MODEL: BK-DEL028-0750Ad

INPUT: 200-240V \approx 0/50/60Hz 0.22A Max. λ : 0.95

OUTPUT: 6-38V \approx 750mA 28.5W 50VDC Max. MADE IN CHINA

Other ratings see selection sheet

For LED Modules use only

www.bokedriver.com

wire prep. 0.75-1.5mm² Preparation for input and output tc:90°C ta:45°C

ACN/DC+ 8-9mm

DA DALI PUSH-DIM

For Australia and New Zealand, the marking "M" label with

Switching selection sheet						
Pin(W)	Output	Switch	1	2	3	4
14.8	12.60	300	6-42	ON	ON	ON
17.0	14.70	350	6-42	ON	ON	ON
19.4	16.80	400	6-42	ON	ON	ON
21.6	18.90	450	6-42	ON	ON	ON
24.1	21.00	500	6-42	ON	ON	ON
26.9	23.10	550	6-42	ON	ON	ON
29.2	25.20	600	6-42	ON	ON	ON
31.8	27.30	650	6-42	ON	ON	ON
32.2	28.00	700	6-40	ON	ON	ON
33.4	28.50	750	6-38	ON	ON	ON

Do not energize the driver before connecting the LED.

Before use, always check dipswitch settings!

DIP-switch & output current

Prated	Irated	output voltage	1	2	3	4
12.60W	300mA	42VDC	--	ON	ON	ON
14.70W	350mA	42VDC	ON	--	ON	ON
16.80W	400mA	42VDC	--	--	ON	ON
18.90W	450mA	42VDC	--	ON	--	ON
21.00W	500mA	42VDC	--	--	--	ON
23.10W	550mA	42VDC	ON	ON	ON	--
25.20W	600mA	42VDC	--	--	ON	--
27.30W	650mA	42VDC	--	ON	--	--
28.00W	700mA	40VDC	ON	--	--	--
28.50W	750mA	38VDC	--	--	--	--

Remarks:

- ★ It means that this item is the factory default current.
- It means that this channel is OFF.

DALI dimming application

Wiring diagram

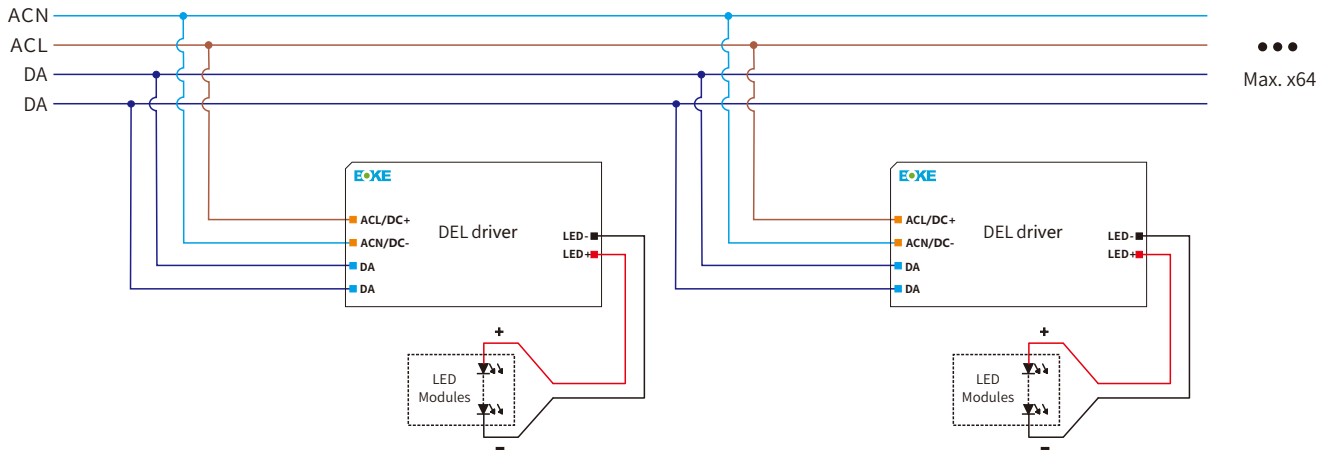

Activating DALI dimming mode

- After installation according to the wiring diagram of DALI dimming application, the driver will automatically switch to the DALI control mode after receiving any DALI command.

Remarks:

- Standard DALI control line voltage range: 9.5V to 22.5V, type 16V.
- The two DALI control lines polarity-reversible.
- Max. 64 DALI drivers per DALI control line.
- The maximum distance length of the DALI control line is 300m at $2 \times 1.5\text{mm}^2$.
- DALI bus can be wired together with any mains voltage cables, but separate wiring is recommended.

Please refer to the table below

Cable size	Distance
$2 \times 0.50\text{mm}^2$	max.100m
$2 \times 0.75\text{mm}^2$	max.150m
$2 \times 1.00\text{mm}^2$	max.200m
$\geq 2 \times 1.50\text{mm}^2$	max.300m

Dimming curve

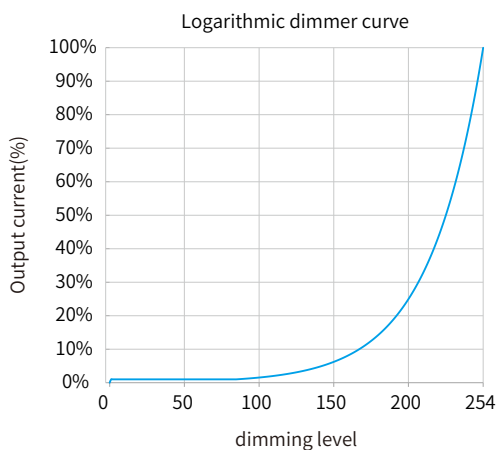

Remarks:

The dimming curve can be selected by DALI configuration. The default is logarithmic dimming curve.

PUSH dimming application

Wiring diagram

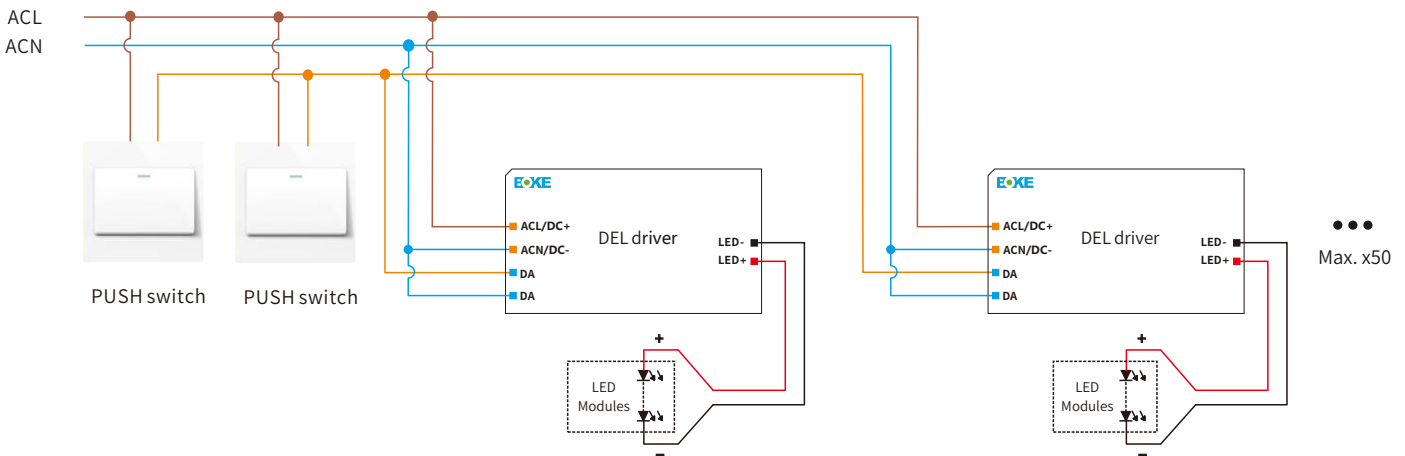

Activating PUSH dimming mode

After installation according to the wiring diagram of PUSH dimming application, short press the PUSH switch 3 times within 3 seconds, the driver will automatically switch to PUSH dimming mode.

Remarks:

Max. 50 drivers per PUSH control line.

Turn on or turn off: short press push switch for 0.2-1s.

Dimming: long press push switch for 1-5s.

Power on status: after power on, the light state will be the same as the lighting on state.

If the light is on before power on, the light will be on after power on again, brightness will be the same as the last lighting on brightness.

If the light is off before power off, the light will be off after power on again, short press the push button, then the light will be on, the brightness will be the same as the last brightness.

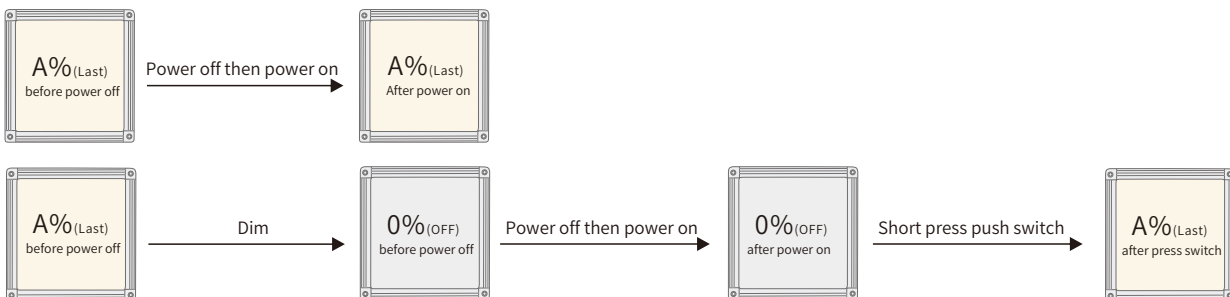

Multiple lights synchronize control operation

method 1:

Step 1: long press the PUSH switch, confirm each light is on.

Step 2: short press the PUSH switch, confirm each light is off.

Step 3: long press the PUSH switch, confirm each light is from darkest to brightest and all the lights are synchronous.

method 2:

- Long press the PUSH switch 15s, all lights output to the brightest state.

Installation

Mechanical dimensions

Unit:mm

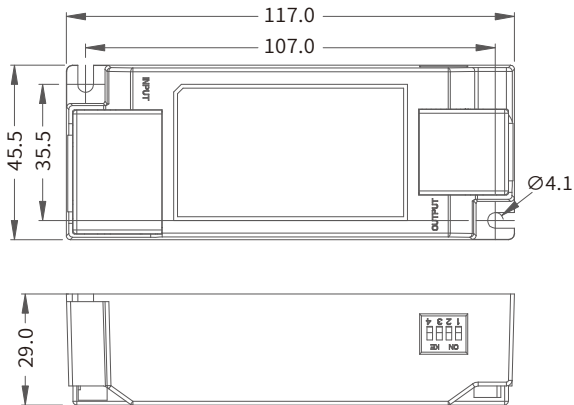

INPUT

Pin Numbering	function	colour
1	ACL/DC+	orange
2	ACN/DC-	orange
3	DA	blue
4	DA	blue

Input wire

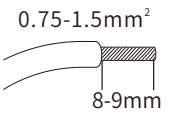

OUTPUT

Pin Numbering	function	colour
1	LED-	black
2	LED+	red

Output wire

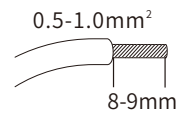

Installation note

Hot plug-in

- Hot plug-in is not supported due to residual output voltage of > 0 V.
- If a LED load is connected the device has to be restarted.
- This can be done via mains reset or via interface (DALI).

Wiring guidelines

- All connections must be kept as short as possible to ensure good EMI behaviour.
- Mains leads should be kept apart from LED Driver and other leads (ideally 5 – 10 cm distance)
- Max. length of output wires is 2 m.
- Incorrect wiring can damage LED modules.

Mounting screw specifications and torque

- Max. torque at the clamping screw: 0.5 Nm / M4

Replace LED module

1. Mains off
2. Remove LED module
3. Wait for 5 seconds
4. Connect LED module again

Packaging

Optional 1: factory default

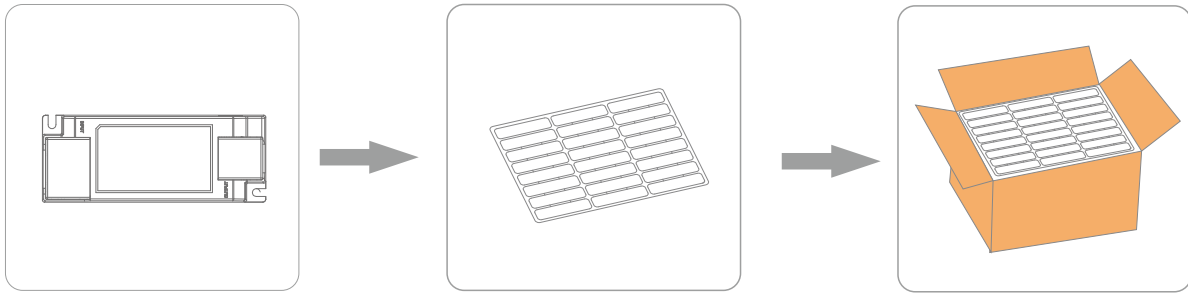

Product

Blister

24pcs×2layer=48pcs/CIN

Model	Product size	Weight	Blister size	Carton size	Qty/carton	N.W	G.W
DEL028	L117*W45.5*H29mm	165g	L430*W340*H47mm	L450*W350*H130mm	48pcs	7.92kg	9.40kg

Optional 2:

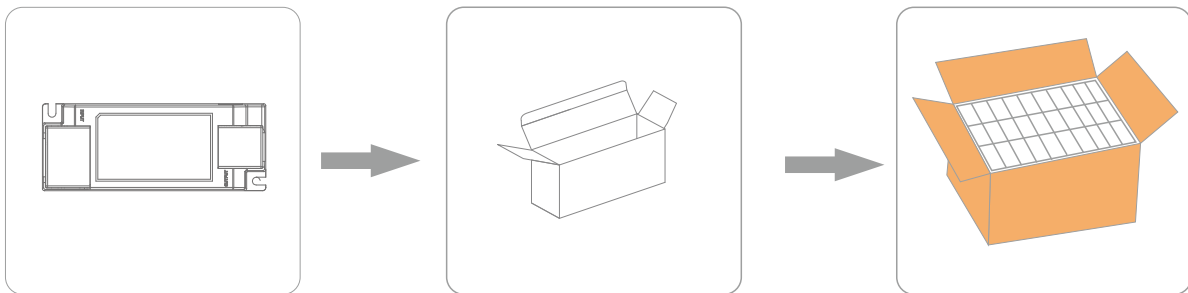

Product

Packaging

18pcs×3layer=54pcs/CIN

Model	Product size	Weight	Packaging size	Carton size	Qty/carton	N.W	G.W
DEL028	L117*W45.5*H29mm	165g	L140*W35*H50mm	L330*W300*H170mm	54pcs	8.90kg	10.5kg

Additional information

1. This product can only be used outside the light body, Can not be used inside of the light, and it must be used within the specified working environment.
2. The life and MTBF of the product are for reference only, and do not represent a warranty statement. If the drive has been turned on, there is no warranty.
3. For more information, please send an email to info@bokedriver.com.