

Constant current independent dimmable driver
PUL-B Series suffix M (1-10V/10V PWM)

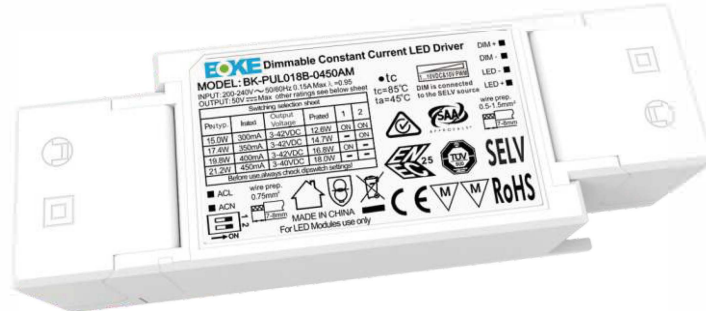

Features

- Support 1-10V/10V PWM dimming mode
- 4-level current output can be realized by DIP-switch
- Soft dimming and flicker-free at any brightness
- Using HPC patented technology at any dimming level, the brightness between lights is same
- Dimming range 1~100%, output current accuracy 1%
- Standby power input<0.5W, meets the requirements of ErP certification
- High PF, high efficiency, low THD
- Screw-free and pressing type strain relief, supports thicker cables and is easier to install
- Independent input and output strain relief, stronger wiring
- SELV and Class II design, suitable for use outside of the light
- Passed ENEC-TUV,CE,RCM,CCC and other certifications
- IP20 protection grade, indoor use
- Nominal life-time up to 100,000 h
- 5-year guarantee

Interfaces

- DIM(1-10V / 10V PWM)

Functions

- Support central emergency application (dimming normal in DC input)
- Support self-contained emergency application
- Protective features (short-circuit ,no-load protection)

Suitable for lights

- Suitable for lights with independent drivers such as downlights, spotlights, panel lights, etc
- Not suitable for lights with built-in drivers

Typical applications

- LED indoor lighting
- LED office lighting
- LED commercial lighting



Model coding rules of PUL-B series

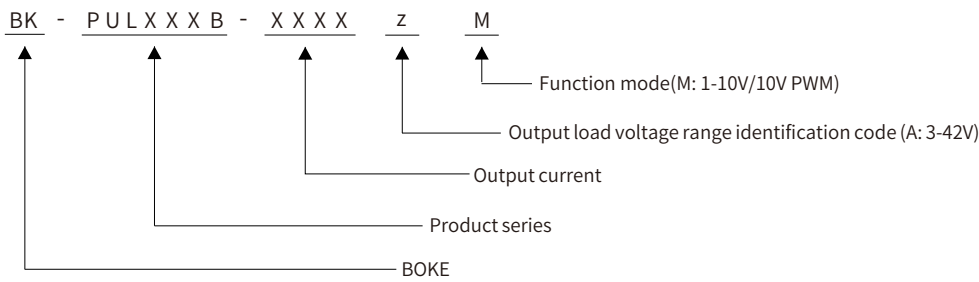

Optional dimming function selection table of PUL-B series

Model	Suffix	Wired dimming		
		DALI-2	PUSH	1-10V 2in1
PUL030A PUL042A	D	√	√	√
	d	√	√	
	P		√	√
PUL060A	M			√
PUL010A	d	√		
PUL018A	P		√	
PUL010B PUL018B	M			√

* The description in this specification is only applicable to the products with the suffix M and the model are PUL010B and PUL018B .

Order selection table of PUL-B series(just suffix P, 10W/18W)

Model	Input voltage	Output power	Output voltage	Output current	Dimension	Article number
BK-PUL010B-0250AM	200-240VAC	10.5W	3-42VDC	0.15-0.25A	L97.5*W44*H30mm	B-PUL010A-HF001A(independent)
BK-PUL010B-0250AM	200-240VAC	10.5W	3-42VDC	0.15-0.25A	L131.5*W44*H30mm	B-PUL010A-HF001B(built-in)
BK-PUL018B-0450AM	200-240VAC	18.0W	3-42VDC	0.30-0.45A	L97.5*W44*H30mm	B-PUL018A-HF001A(independent)
BK-PUL018B-0450AM	200-240VAC	18.0W	3-42VDC	0.30-0.45A	L131.5*W44*H30mm	B-PUL018A-HF001B(built-in)

Technical data

Product model	BK-PUL010B-0250AM
Output parameters	
Regulation method	Constant Current
Rated output current	0.15-0.25A
Rated output voltage	3-42V
Rated output power	10.5W Max
Output current adjustment	DIP S.W(4 levels)
Output current ripple LF	±1%
Output current accuracy	±2%
Linear regulation	±1%
Load regulation	±1%
No load output voltage	50V
Flicker-free(typical)	Modulation depth =0.752% (5976 kHz), Pst LM ≤ 0.000, SVM ≤ 0.002,(The above parameters are obtained from testing the panel lights)
Input parameters	
Rated input voltage	200-240VAC 200-240VDC
Rated input voltage	180-264VAC 180-264VDC
Input voltage shock	<380V AC, 1 h
Input current	<0.1A (AC input)
Input frequency	47-63Hz
Input power factor	>0.95 (230V AC & Full load)
Input THD	<10% (230V AC & Full load)
Efficiency(typical)	82% (230V AC & Full load)
In-rush current	3.32A peak ,198us duration(50 % Ipeak), see the description below for details
Start/Switchover/Turn off	<0.6s(AC start),<0.6s(DC start),<0.3s(AC/DC switchover),<0.5s(Turn off)
Switching cycles	> 50,000 switching cycles
Power consumption	Full load(Pmax):10.5W, No load(Pno): N/A, On stand-by(Psb) : <0.5W, Network stand-by(Pnet) : N/A
Safety	
Withstand voltage	I/P-O/P:3750V AC
Mains surge capability	L-N:2KV
Leakage current	<0.7mA (230V AC & Full load)
Isolation resistance	I/P-O/P:100MΩ/500Vdc/25°C/70% RH
Control interface	
DALI dimming port	N/A
PUSH dimming port	N/A
1-10V 2in1 dimming port	Voltage range: 0-10V, interface current consumption: 0.3mA
Auxiliary power supply	N/A
Dimming range	1-100%
Dimming drive mode	AM(amplitude modulation)
Emergency support	
Central emergency system	Supported(Under DC input conditions)
Self-contained emergency	Supported
Environment & Life time	
Operating temperature	Ta=-20-60°C
Case temperature	Tc=85°C
Operating humidity	5-85% RH, not condensed
Storage temp./humidity	-40-80°C, 5-85% RH, not condensed
IP grade	IP20
MTBF	500,000H,MIL-HDBK-217F(25°C)
Life-time	Nominal life-time up to 100,000 h, see the description below for details
Vibration resistant	10~500Hz,5G 12min./1cycle,period for 72min. each along X,Y,Z axes
Acoustic Noise	<25dB(30cm, Full load)
Environmental protection	RoHS
Certifications and standards	
Certified	ENEC-TUV, RCM, EMC, CE, CCC
Safety	EN61347-1, EN61347-2-13, EN62384
EMC	EN55015, EN61000-3-2 , EN61000-3-3, EN61000-4-2,3,4,5,6,8,11, EN61547
DALI-2	N/A
EL	Compatible IEC 61347-2- 13 Annex J, compatible with EN 60598-2-22 and EN 50172
RF	N/A

Remarks

- 1.By default, all parameter are measured at 230VAC input, full load and 25°C of ambient temperature.
- 2.The driver can not be installed inside the light. when the driver is used with the light, the EMC of the whole light needs to be tested.

Technical data

Product model	BK-PUL018B-0450AM
Output parameters	
Regulation method	Constant Current
Rated output current	0.3-0.45A
Rated output voltage	3-42V
Rated output power	18W Max
Output current adjustment	DIP S.W(10 levels)
Output current ripple LF	±1%
Output current accuracy	±2%
Linear regulation	±1%
Load regulation	±1%
No load output voltage	50V
Flicker-free(typical)	Modulation depth =0.263% (5717 kHz), Pst LM ≤ 0.000, SVM ≤ 0.004,(The above parameters are obtained from testing the panel lights)
Input parameters	
Rated input voltage	200-240VAC 200-240VDC
Rated input voltage	180-264VAC 180-264VDC
Input voltage shock	<380V AC, 1 h
Input current	<0.15A (AC input)
Input frequency	47-63Hz
Input power factor	>0.95 (230V AC & Full load)
Input THD	<10% (230V AC & Full load)
Efficiency(typical)	84% (230V AC & Full load)
In-rush current	3.83A peak ,184us duration(50 % Ipeak), see the description below for details
Start/Switchover/Turn off	<0.6s(AC start),<0.6s(DC start),<0.3s(AC/DC switchover),<0.5s(Turn off)
Switching cycles	> 50,000 switching cycles
Power consumption	Full load(Pmax):18W, No load(Pno): N/A, On stand-by(Psb) : <0.5W, Network stand-by(Pnet) : N/A
Safety	
Withstand voltage	I/P-O/P:3750V AC
Mains surge capability	L-N:2KV
Leakage current	<0.7mA (230V AC & Full load)
Isolation resistance	I/P-O/P:100MΩ/500Vdc/25°C/70% RH
Control interface	
DALI dimming port	N/A
PUSH dimming port	N/A
1-10V 2in1 dimming port	Voltage range: 0-10V, interface current consumption: 0.3mA
Auxiliary power supply	N/A
Dimming range	1-100%
Dimming drive mode	AM(amplitude modulation)
Emergency support	
Central emergency system	Supported(Under DC input conditions)
Self-contained emergency	Supported
Environment & Life time	
Operating temperature	Ta=-20-45°C
Case temperature	Tc=85°C
Operating humidity	5-85% RH, not condensed
Storage temp./humidity	-40-80°C, 5-85% RH, not condensed
IP grade	IP20
MTBF	500,000H,MIL-HDBK-217F(25°C)
Life-time	Nominal life-time up to 100,000 h, see the description below for details
Vibration resistant	10~500Hz,5G 12min./1cycle,period for 72min. each along X,Y,Z axes
Acoustic Noise	<25dB(30cm, Full load)
Environmental protection	RoHS
Certifications and standards	
Certified	ENEC-TUV, RCM, EMC, CE, CCC
Safety	EN61347-1, EN61347-2-13, EN62384
EMC	EN55015, EN61000-3-2 , EN61000-3-3, EN61000-4-2,3,4,5,6,8,11, EN61547
DALI-2	N/A
EL	Compatible IEC 61347-2- 13 Annex J, compatible with EN 60598-2-22 and EN 50172
RF	N/A

Remarks

- 1.By default, all parameter are measured at 230VAC input, full load and 25°C of ambient temperature.
- 2.The driver can not be installed inside the light. when the driver is used with the light, the EMC of the whole light needs to be tested.

BK-PUL018B-0450AM (Continue)

Efficiency vs load

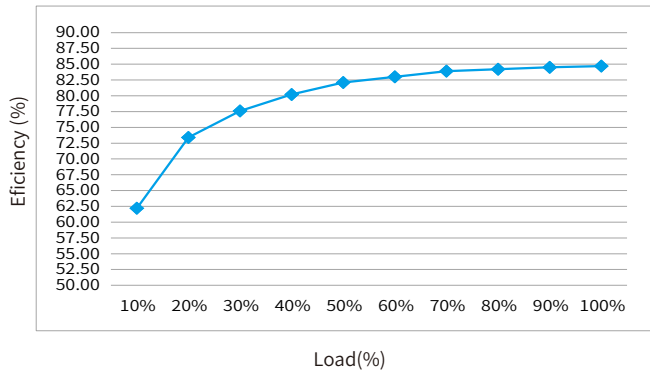

THD vs. Load

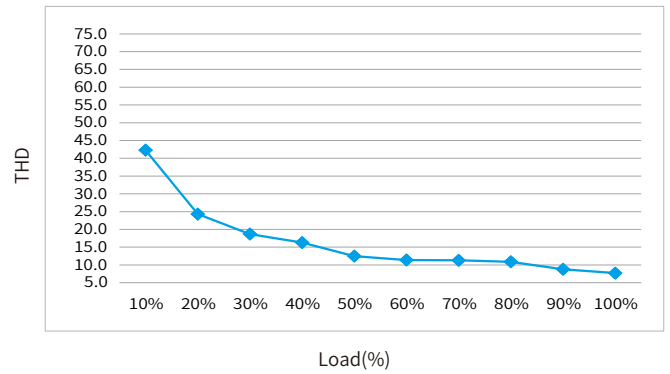

Power factor vs. Load

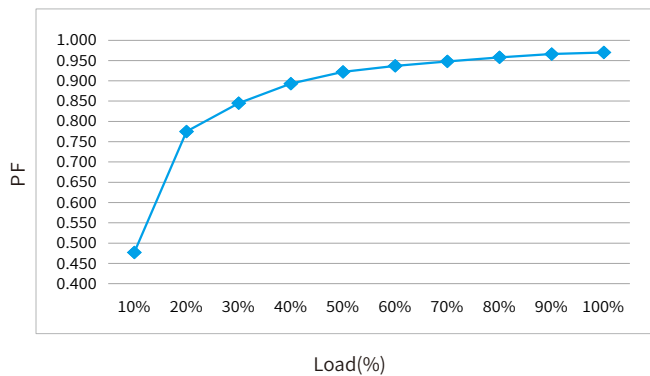

Expected life-time

BK-PUL010B-0250AM

Life-time vs. case temperature

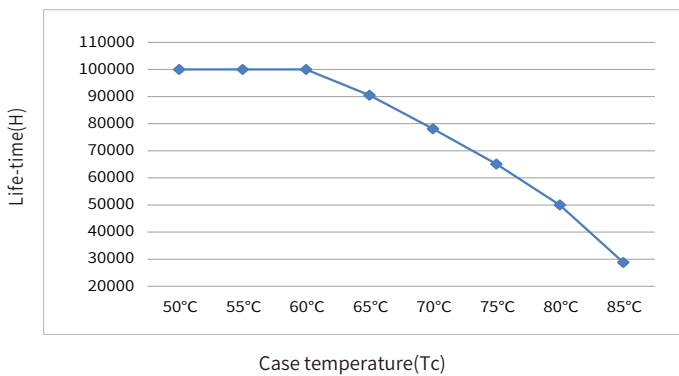

BK-PUL018B-0450AM

Life-time vs. case temperature

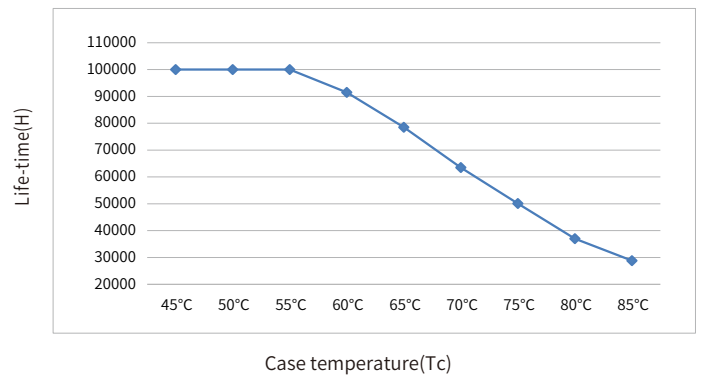

-The life-time of the LED driver is shown in the figure above (calculated based on the 90% survival rate).

- The relation of tc to ta temperature depends also on the luminaire design.

Electrical values

BK-PUL010B-0250AM

Operating window

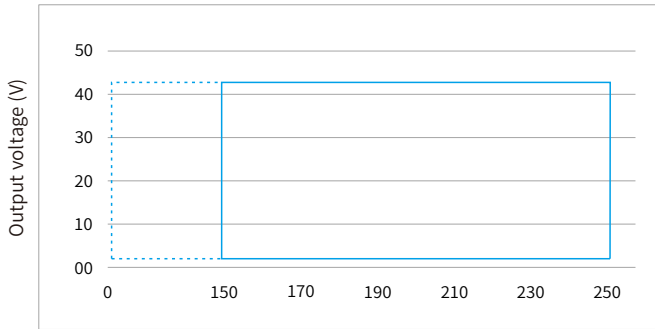

Output current(mA) — Operating window 100 %
 Operating window dimmed

Operating window

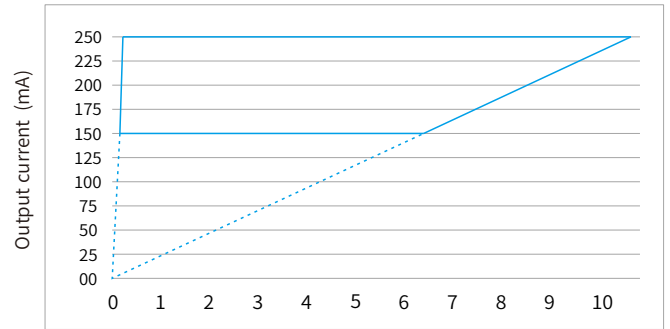

Output power(W) — Operating window 100 %
 Operating window dimmed

Efficiency vs load

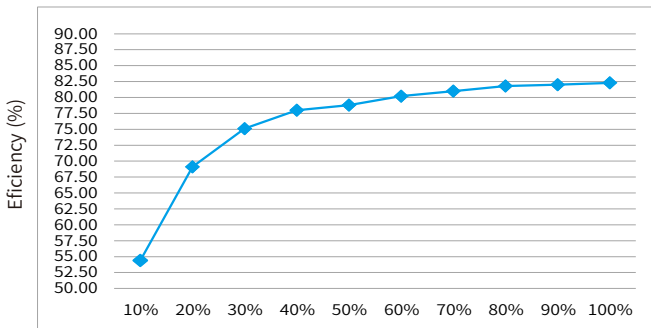

Load(%)

THD vs. Load

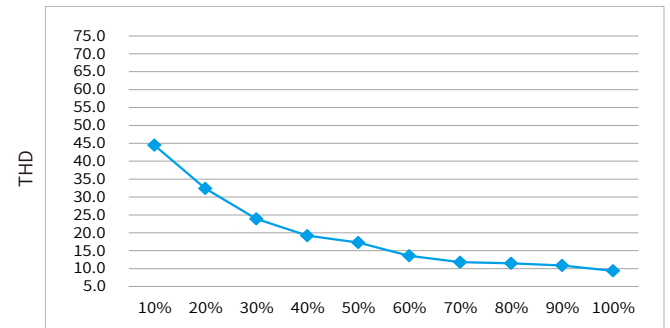

Load(%)

Power factor vs. Load

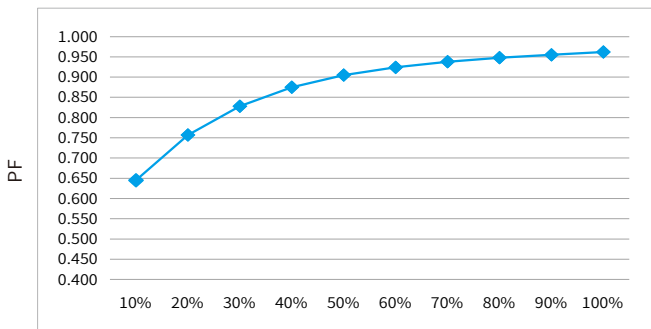

Load(%)

BK-PUL018B-0450AM

Operating window

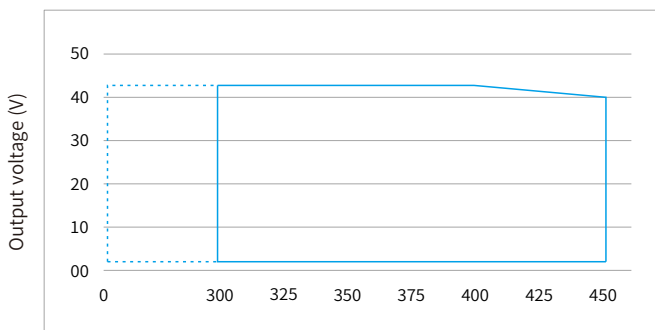

Output current(mA) — Operating window 100 %
 Operating window dimmed

Operating window

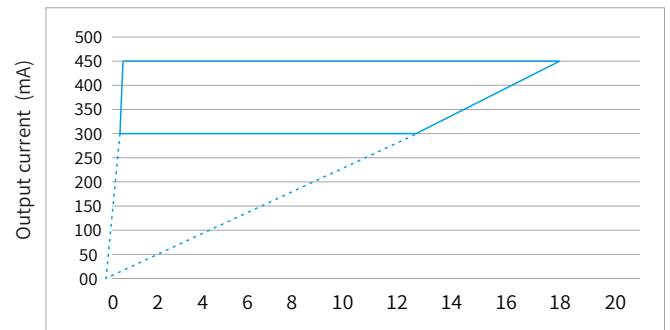

Output power(W) — Operating window 100 %
 Operating window dimmed

Surge

Model	I _{peak}	T _{width}	Condition	Relative number of MCB															
				B10	B13	B16	B20	B25	C10	C13	C16	C20	C25	D10	D13	D16	D20	D25	
BK-PUL010B-0250AM	3.32A	198us	AC 230V, Full load, Cold start, T _a ≤ 30°C, MCB is not installed side by side	95	123	152	192	237	122	159	195	244	305	122	159	195	244	305	
BK-PUL018B-0450AM	3.83A	184us		73	95	117	146	182	73	95	117	146	182	73	95	117	146	182	

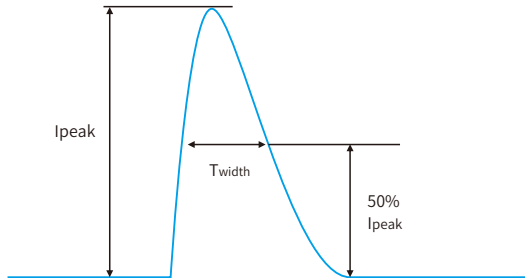

Remarks

- The number of drives mounted under different MCBs in the table is the maximum value. Please do not exceed this number during installation.
- Calculation uses typical values from ABB series S200 as a reference.
- Different brands and models of miniature circuit breakers, the number of drives mounted will be slightly different.
- If the ambient temperature of the MCB installation exceeds 30°C or multiple MCBs are installed side by side, the number of drives mounted will be reduced and the calculation needs to be recalculated.
- Electrician's usually consider Type B for household lighting and Type C for commercial lighting application.

Functions

Output short-circuit behaviour

- In case of a short-circuit at the LED output, the LED output is switched off.
- After restart of the LED driver, the output will be activated again.
- The restart can either be done via mains reset or via interface (1-10V).

Output no-load operation

- The LED driver will not be damaged in no-load operation.
- The output will be deactivated and is therefore free of voltage.
- If a LED load is connected the device has to be restarted before the output will be activated again.
- The restart can either be done via mains reset or via interface (1-10V).

1-10V/10V PWM dimming application

Wiring diagram

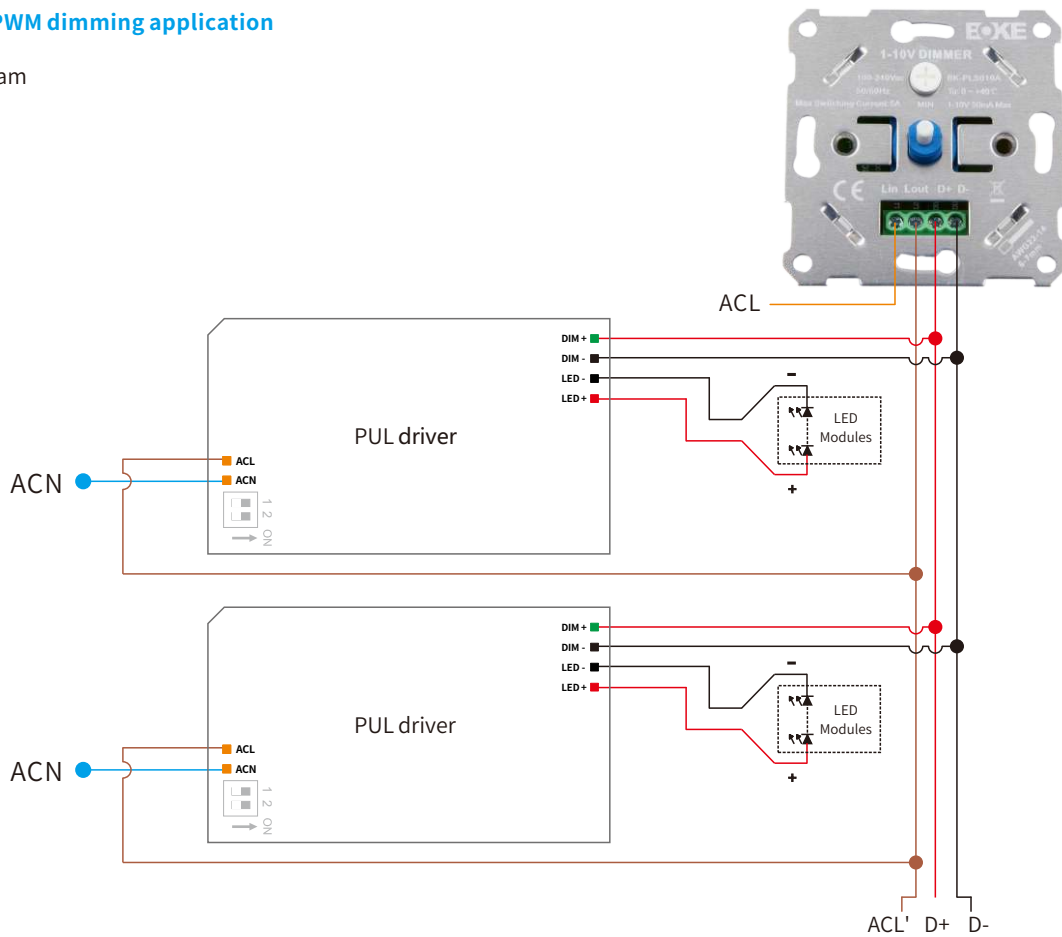

Remarks

- Dimming interface characteristics: 0.9V and below are closed, 1V is the darkest, 10V is the brightest, 1-10V is the dimming range.
- The dimming interface distinguishes between positive and negative, DIM+ is positive, DIM- is negative, please do not reverse.
- Dimming interface does not support voltage access higher than 20V, otherwise it will cause damage to the internal components.
- When the dimming interface is open, the driver outputs the maximum current. When the interface is short-circuited, the current output is closed.
- When multiple synchronous dimming is required, the positive poles of the dimming interface of each driver are connected together, and the negative poles are connected together.
- Support passive dimmer or isolated active dimmer dimming, does not support non-isolated active dimmer dimming.
- In general, it is recommended that the number of mounted drives does not exceed 30pcs, and the wiring length does not exceed 100m.
- It is recommended that the dimming wires should not be lower than the 22AWG wire.
- Do not put the dimming wires with high voltage or interference sources. If it is unavoidable, please use the shielded wires.
- If you need a drive with 0-10V dimming characteristics, please contact BOKE.

Dimming curve

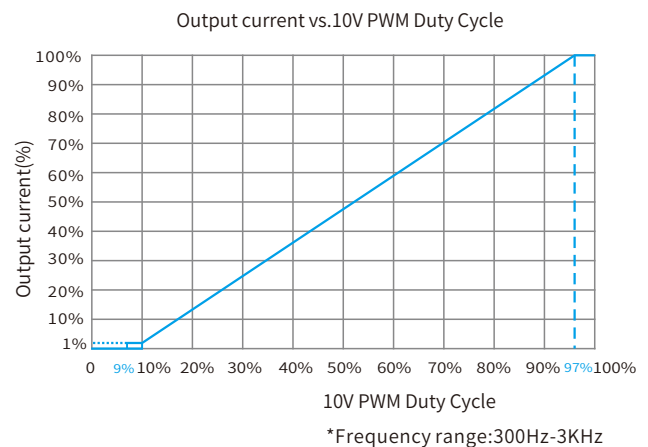
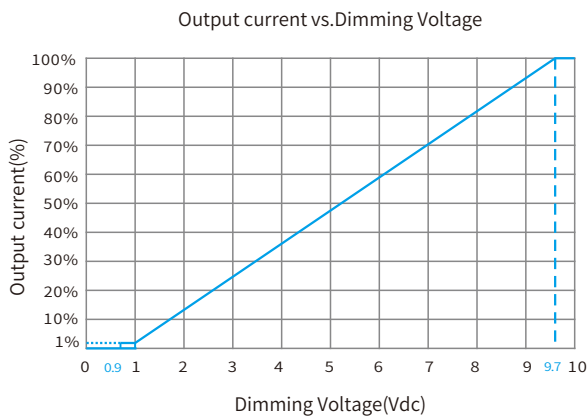

DIP-switch & output current

BK-PUL010B-0250AM

Switching selection sheet					
PIN typ.	Irated	Output Voltage	Prated	1	2
8.0W	150mA	3-42VDC	6.3W	ON	ON
9.2W	175mA	3-42VDC	7.35W	—	ON
10.4W	200mA	3-42VDC	8.4W	ON	—
12.8W	250mA ★	3-42VDC	10.5W	—	—

Before use, always check dipswitch settings!

Label

BOKE Dimmable Constant Current LED Driver
MODEL: BK-PUL010B-0250AM
 INPUT: 200-240V ~50/60Hz 0.1A Max $\lambda = 0.95$
 OUTPUT: 50V ~Max other ratings see below sheet

Switching selection sheet					
PIN typ.	Irated	Output Voltage	Prated	1	2
8.0W	150mA	3-42VDC	6.3W	ON	ON
9.2W	175mA	3-42VDC	7.35W	—	ON
10.4W	200mA	3-42VDC	8.4W	ON	—
12.8W	250mA	3-42VDC	10.5W	—	—

Before use, always check dipswitch settings!

BK-PUL018B-0450AM

Switching selection sheet					
PIN typ.	Irated	Output Voltage	Prated	1	2
15.0W	300mA	3-42VDC	12.6W	ON	ON
17.4W	350mA	3-42VDC	14.7W	—	ON
19.8W	400mA	3-42VDC	16.8W	ON	—
21.2W	450mA ★	3-40VDC	18.0W	—	—

Before use, always check dipswitch settings!

BOKE Dimmable Constant Current LED Driver
MODEL: BK-PUL018B-0450AM
 INPUT: 200-240V ~50/60Hz 0.15A Max $\lambda = 0.95$
 OUTPUT: 50V ~Max other ratings see below sheet

Switching selection sheet					
PIN typ.	Irated	Output Voltage	Prated	1	2
15.0W	300mA	3-42VDC	12.6W	ON	ON
17.4W	350mA	3-42VDC	14.7W	—	ON
19.8W	400mA	3-42VDC	16.8W	ON	—
21.2W	450mA	3-40VDC	18.0W	—	—

Before use, always check dipswitch settings!

Remarks:

- ★ It means that this item is the factory default current.
- It means that this channel is OFF.

Installation

Mechanical dimensions

Unit:mm

Built-in controlgear

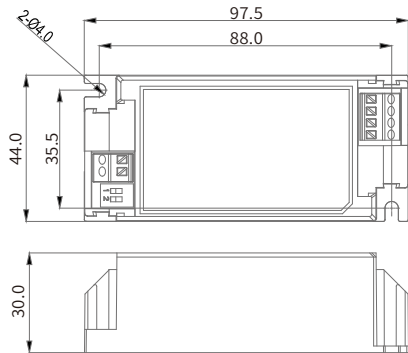

Independent controlgear

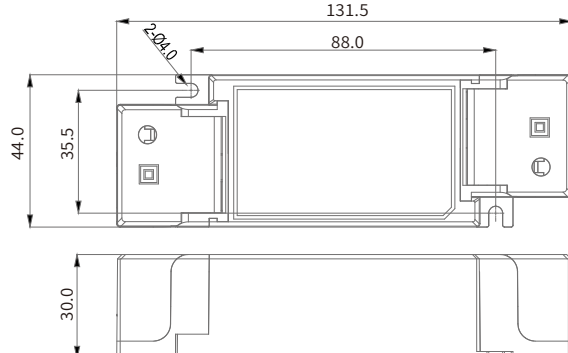

INPUT

Pin Numbering	function	colour
1	ACL	orange
2	ACN	orange

Input wire

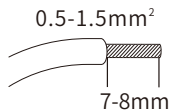

OUTPUT

Pin Numbering	function	colour
1	DIM+	green
2	DIM-	black
3	LED-	black
4	LED+	red

Output wire

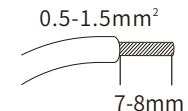

Installation note

Hot plug-in

- Hot plug-in is not supported due to residual output voltage of > 0 V.

Wiring guidelines

- All connections must be kept as short as possible to ensure good EMI behaviour.
- Mains leads should be kept apart from LED Driver and other leads (ideally 5 - 10 cm distance)
- Max. length of output wires is 2 m.
- Incorrect wiring can damage LED modules.

Mounting screw specifications and torque

- Max. torque at the clamping screw: 0.5 Nm / M4

Replace LED module

1. Mains off
2. Remove LED module
3. Wait for 5 seconds
4. Connect LED module again

Packaging

Optional 1: factory default

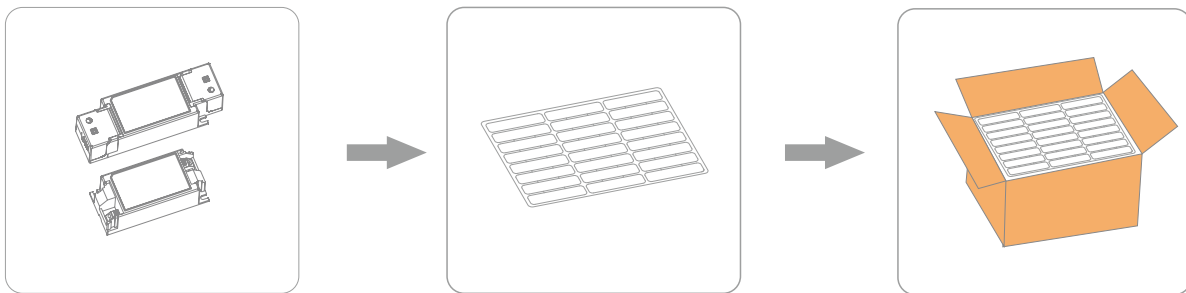

Product

Blister

27pcs×3layer=81pcs/CIN
24pcs×3layer=72pcs/CIN

Model	Product size	Weight	Blister size	Carton size	Qty/carton	N.W	G.W
PUL010B PUL018B (Built-in)	L97.5*W44*H30mm	84g	L430*W340*H47mm	L450*W350*H180mm	81pcs	6.8KG	7.76KG
PUL010B PUL018B (Independent)	L131.5*W44*H30mm	104g	L430*W340*H47mm	L450*W350*H180mm	72pcs	7.5KG	8.5KG



Press line

Remarks: accessories will be packed in PE bags separately

Optional 2:

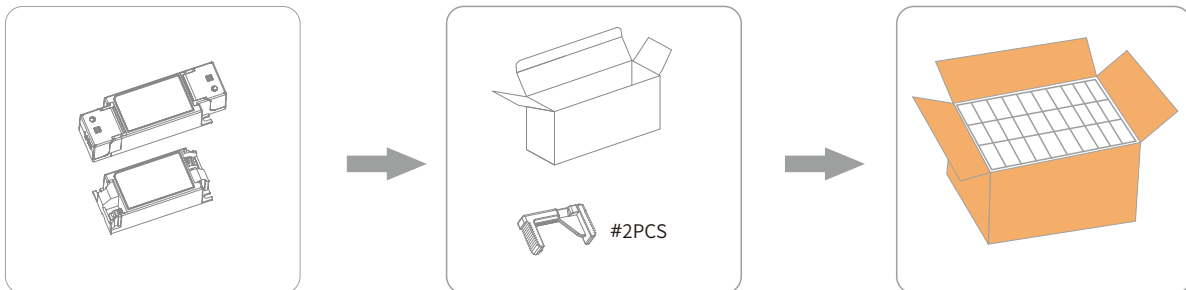

Product

Packaging

30pcs×4layer=120pcs/CIN

Model	Product size	Weight	Packaging size	Carton size	Qty/carton	N.W	G.W
PUL010B PUL018B (Built-in)	L97.5*W44*H30mm	84g	L140*W35*H50mm	L440*W375*H222mm	120pcs	10.8KG	13.5KG
PUL010B PUL018B (Independent)	L131.5*W44*H30mm	104g	L140*W35*H50mm	L440*W375*H222mm	120pcs	12.48KG	15.12KG

Additional information

1. This product can only be used outside the light body, Can not be used inside of the light, and it must be used within the specified working environment.
2. The life and MTBF of the product are for reference only, and do not represent a warranty statement. If the drive has been turned on, there is no warranty.
3. For more information, please send an email to info@bokedriver.com.